

Intake Manifold Spacer

advanced FLOW engineering

Instruction Manual P/N: 46-33024

Make: Ford

Model: F-250/F-350 Super Duty

Year: 2020-2023

Engine: V-8 7.3L



- Please read the entire instruction manual before proceeding.
- Ensure all components listed are present.
- For technical support please call 951-493-7185.
- Ensure you have all necessary tools before proceeding.
- Do not attempt to work on your vehicle when the engine is hot.
- Retain factory parts for future use.

Label	Qty.	Description	Part Number
A	2	Spacers, Intake Manifold	05-61111
B	10	Sleeves, Intake Manifold	05-61112
C	10	Screws, Socket Head Cap M6x1.0x55mm	03-50653
D	8	Seals, Intake Manifold	05-61110

Installation will require the following tools:

7mm nut driver, 8mm socket, 3" / 6" extension, ratchet, 5/16 fuel disconnect tool, 3/8 fuel disconnect tool, clip lifter tool, T-45 Torx bit, drift punch, hammer, small pry bar

Warranty Information available at: <https://afepower.com/contact#warranty>

Emissions Disclaimer: This product is not currently CARB exempt and is not available for purchase in California or for use on any vehicle registered with the California Department of Motor Vehicles.

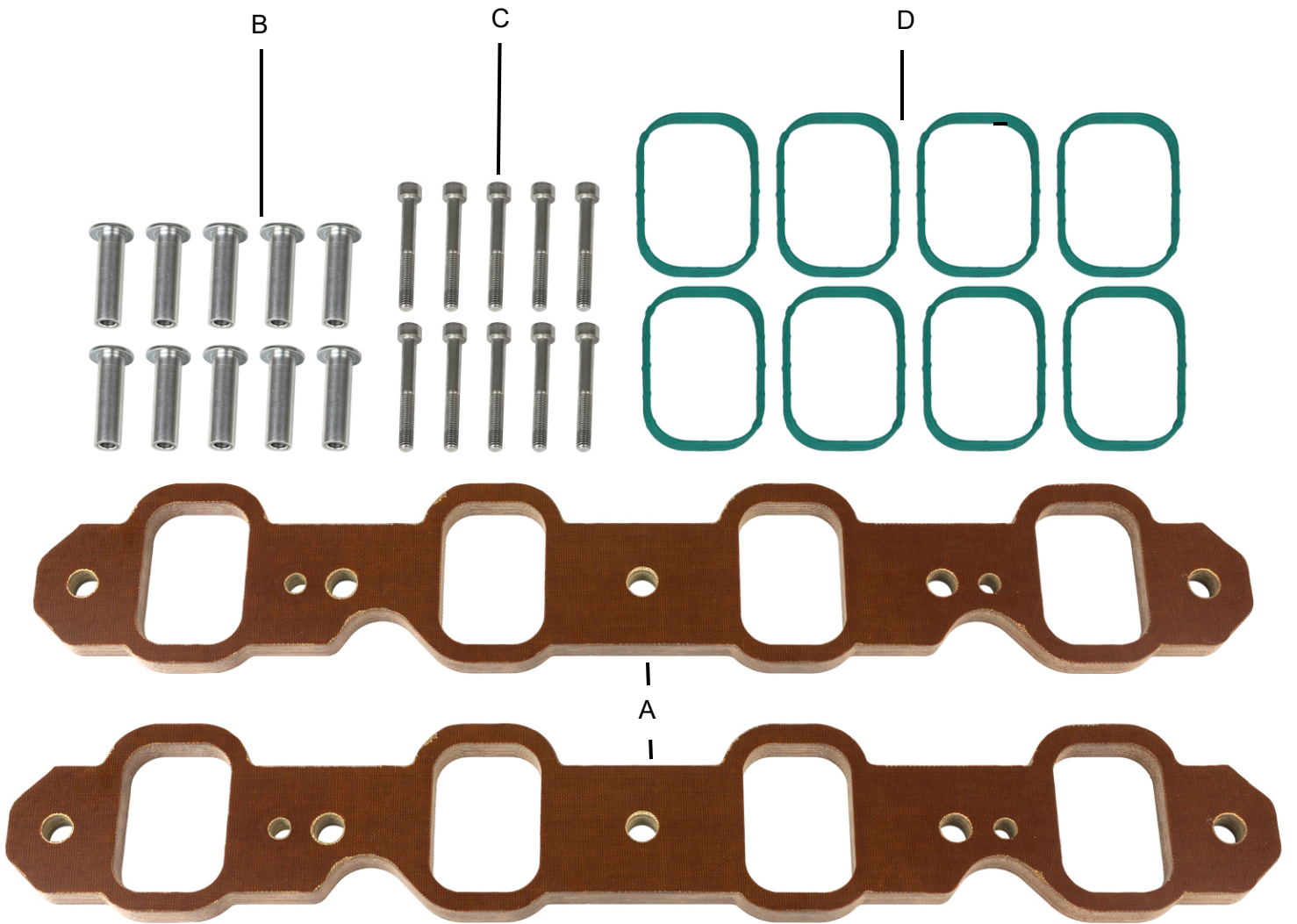



Figure A

Refer to Figure A for Steps 1-5

Step 1: Disconnect the wires from the battery (1).

Step 2: Disconnect the two (2) quick disconnect fittings (2) on the intake tube.

Step 3: Disconnect the connector from the mass air flow (MAF) (3) sensor on the air filter cover.

Step 4: Unclip the air filter cover (4).

Step 5: Using a 7mm nut driver, loosen the clamp from the throttle body. Remove the air intake system (5) from the vehicle. Save for reinstallation.

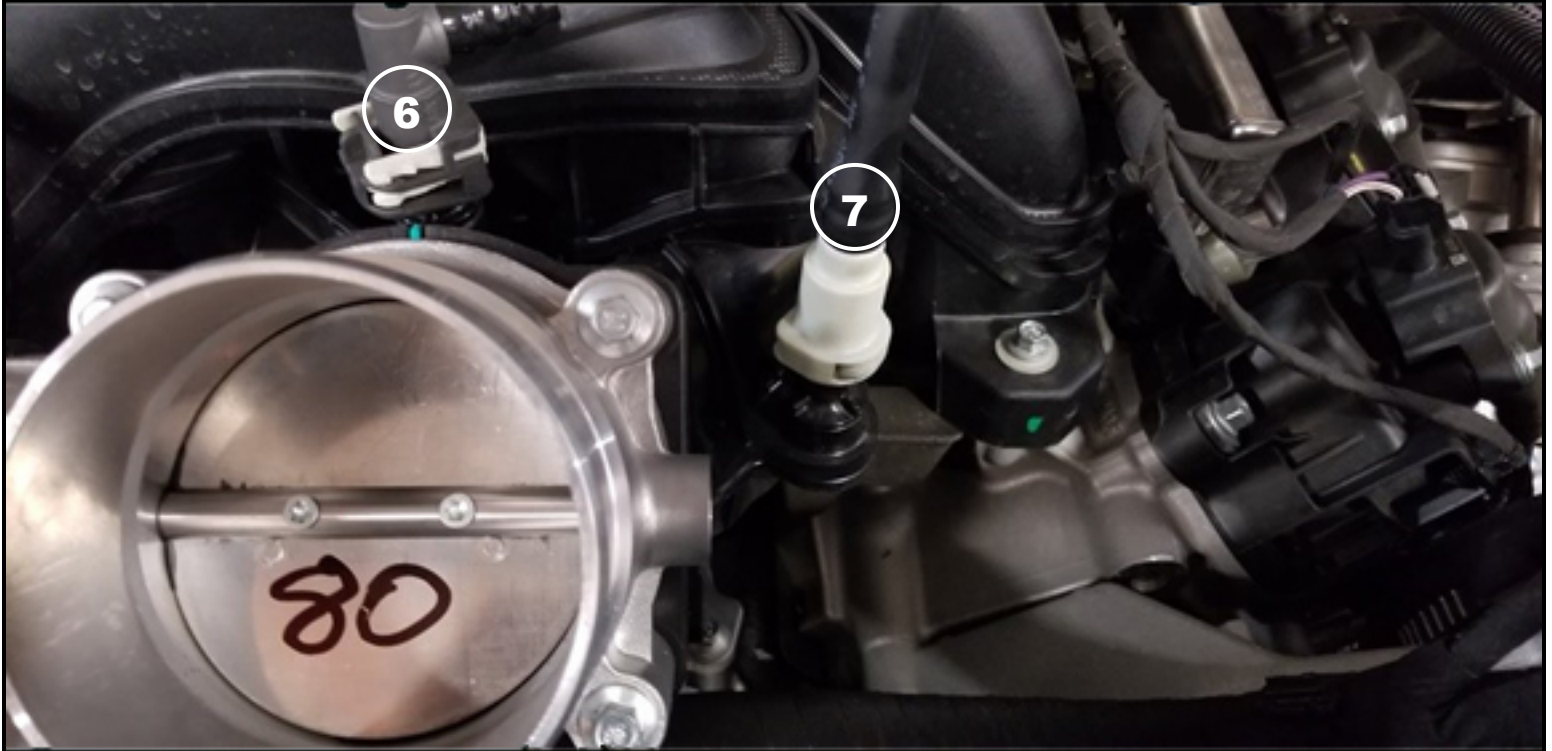

Figure B

Refer to Figure B for Step 6

Step 6: Disconnect the two (2) quick disconnect fittings ⑥ ⑦ from the intake manifold.



Figure C

Refer to Figure C for Step 7

Step 7: Remove the CCV tube by disconnecting the quick disconnect fittings (8) from behind the throttle body and on the valve cover. Remove the line from the vehicle. Save for reinstallation.



Figure D

Refer to Figure D for Steps 8-9

NOTE: Please use caution when performing the next steps. May have residual pressure in the fuel line.

Step 8: Using a 3/8 fuel line disconnect tool, disconnect the fuel line ⑨ from the rail on the passenger's side.

There may be some residual pressure in the line so be careful when pulling apart.

Step 9: Using a 5/16 fuel line disconnect tool, disconnect the fuel line ⑩ from the rail on the driver's side.

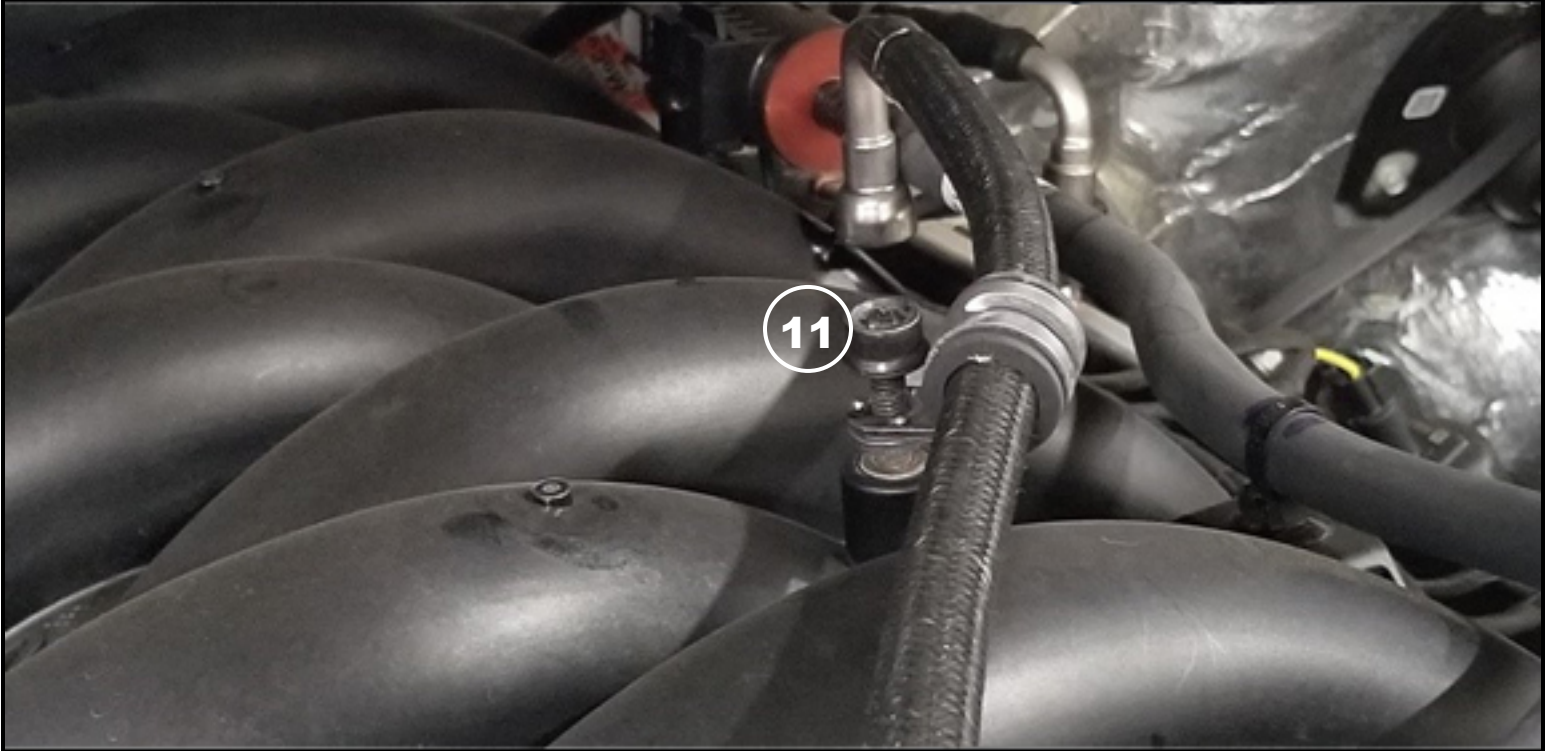

Figure E

Refer to Figure E for Step 10

Step 10: Using a T-45 Torx bit, remove the screw (11) on top of the intake manifold. Remove the fuel line from the vehicle and save for reinstallation.

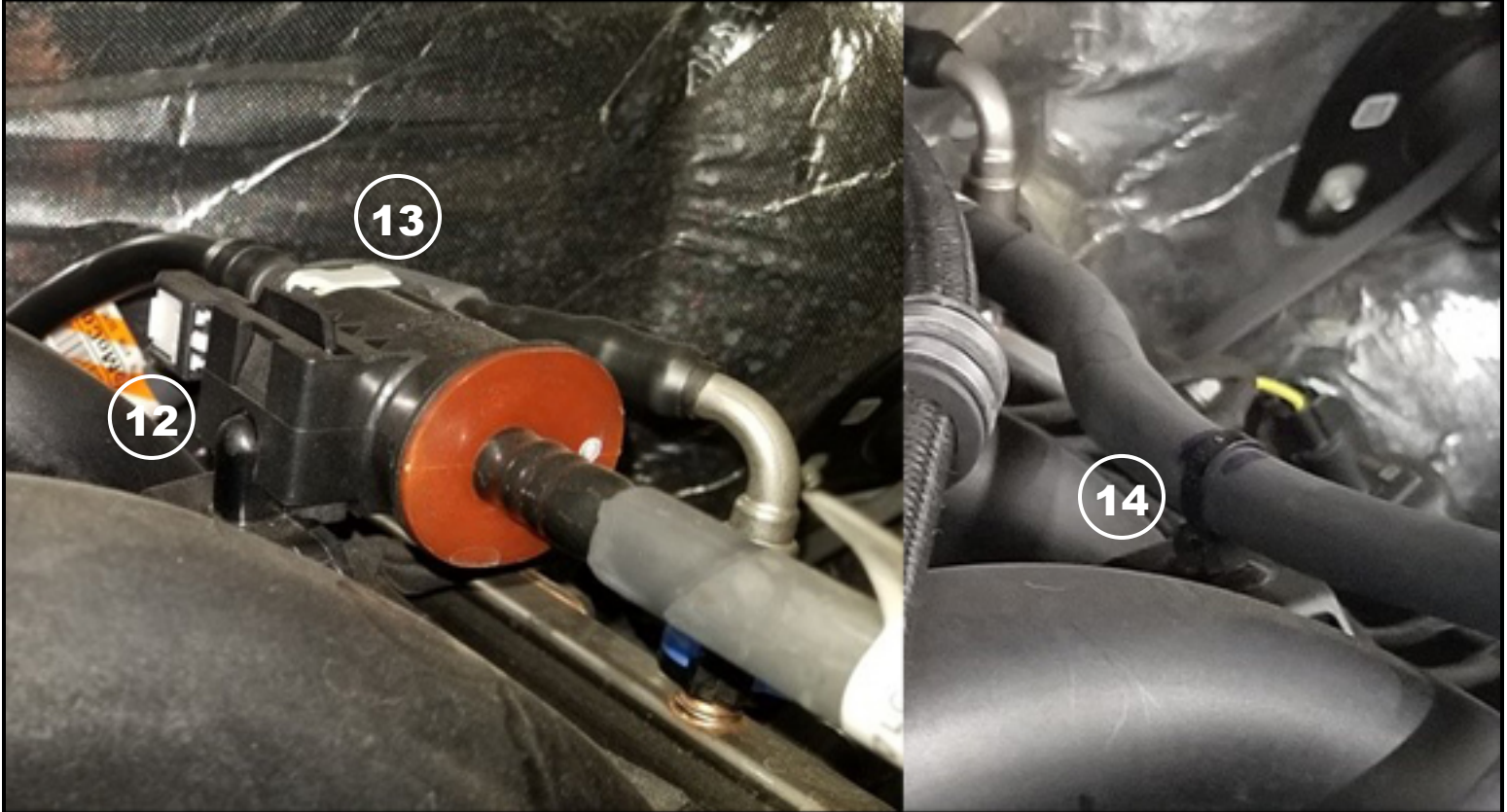

Figure F

Refer to Figure F for Steps 11-14

- Step 11: Disconnect the electrical connector (12) from the fuel evaporative control solenoid.
- Step 12: Disconnect the quick disconnect fitting (13) from the fuel evaporative control solenoid.
- Step 13: Using the clip lifter tool, remove the push clip (14) which attaches the fuel evaporative control tube to the front of the intake manifold.
- Step 14: Using a small prybar and a light amount of lubricant, pry the fuel evaporative control solenoid off the intake manifold. Save for reinstallation.

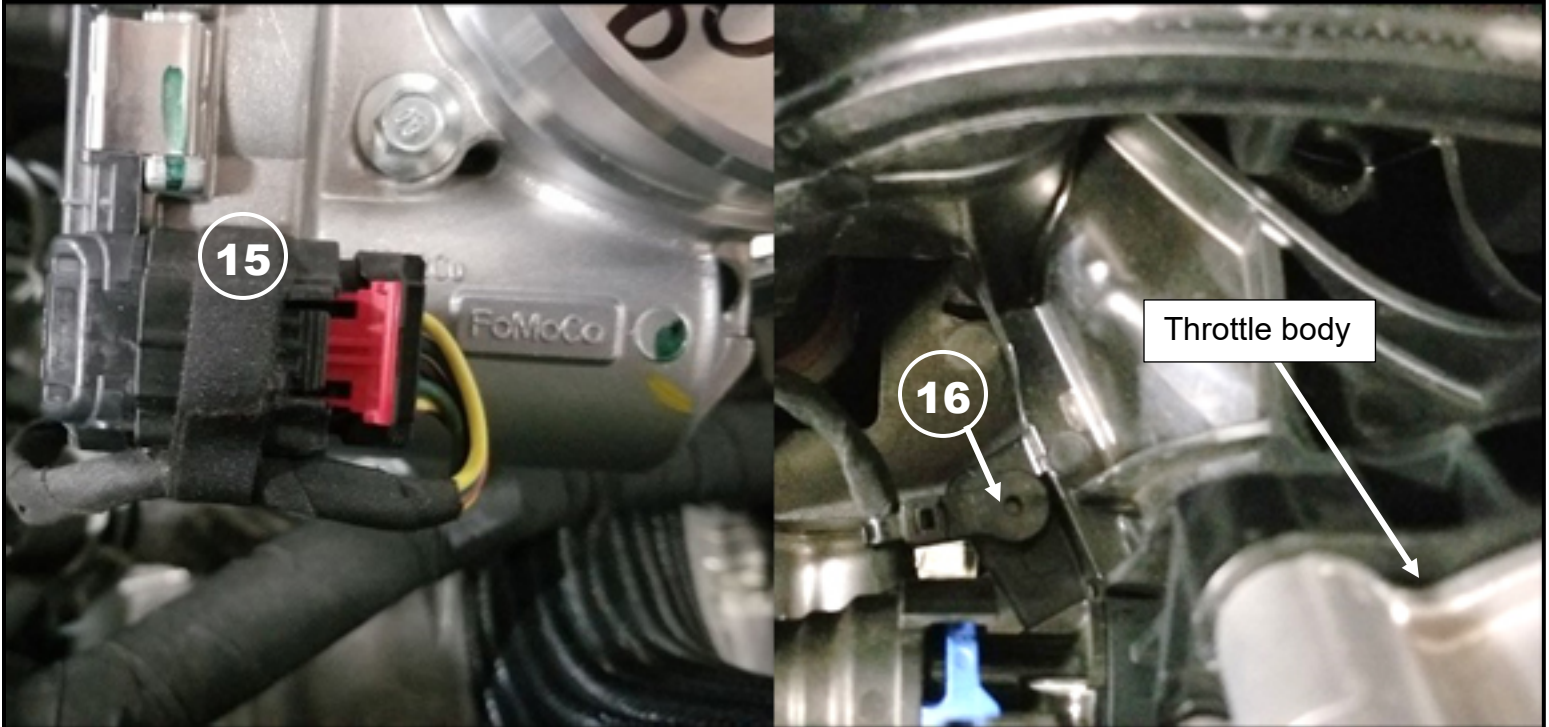

Figure G

Refer to Figure G for Steps 15-16

Step 15: Disconnect the electrical connector (15) from the throttle body.

Step 16: After disconnecting the throttle body, follow the wire to a push clip attaching the wire to the intake manifold. Using the clip lifter tool, remove the push clip (16) from the intake manifold.



Figure H

Refer to Figure H for Step 17

Step 17: Using the clip lifter tool, remove the push clip ⑰ from below the throttle body.

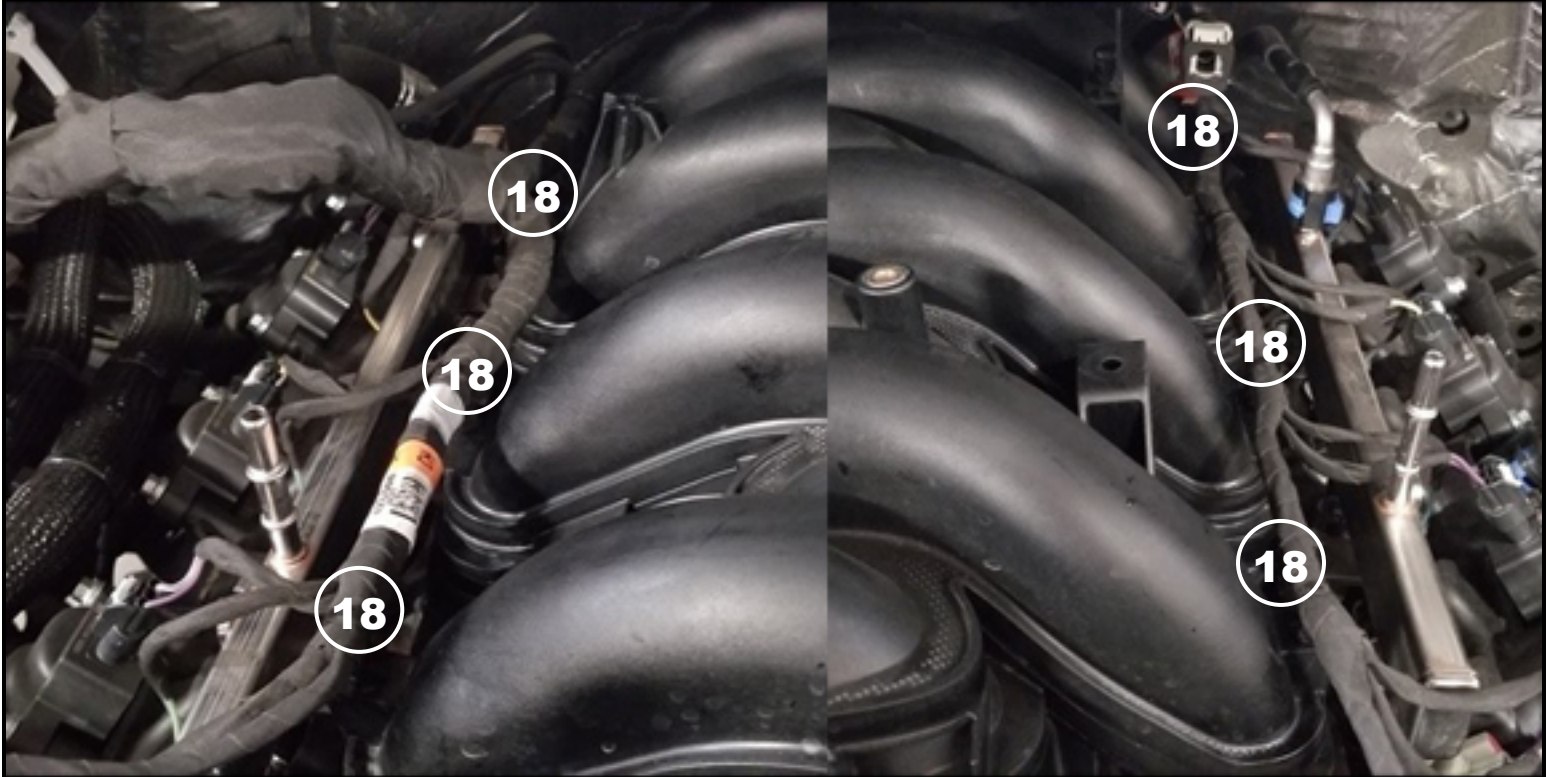

Figure I

Refer to Figure I for Step 18

Step 18: Using the clip lifter tool, remove the six (6) push clips (18) which retain the wiring for the injectors and coil packs.

NOTE: Carefully pull the wire looms over the fuel rails to make clearance for the intake manifold to come out.

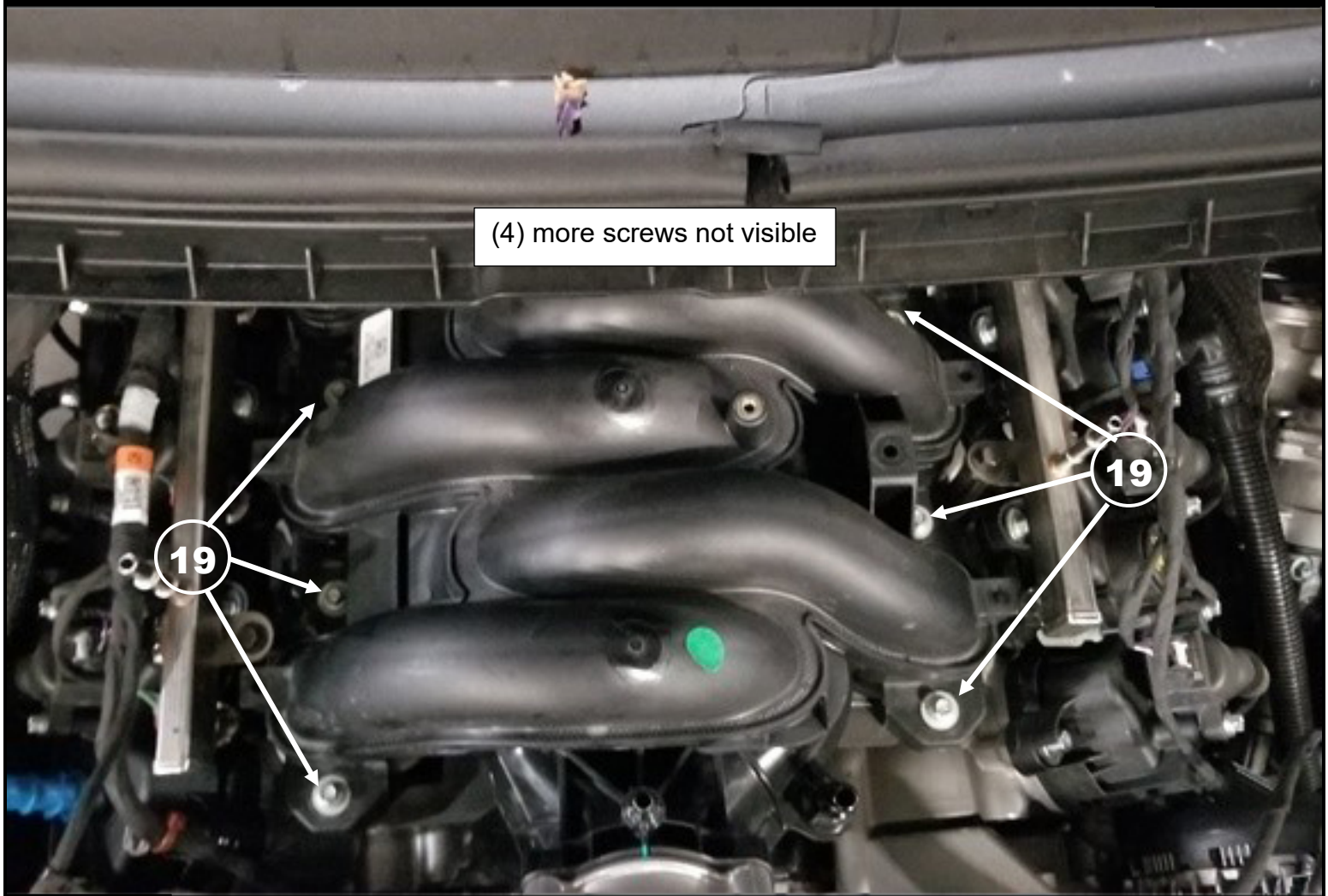

Figure J

Refer to Figure J for Step 19

Note: Please read Step 18 prior to removing the intake manifold

Step 19: Using the 8mm socket and ratchet with extensions, remove the ten (10) screws (19) that retain the intake manifold. Do not remove the intake manifold at this time.



Figure K

Refer to Figure K for Steps 20-21

Step 20: Before removing the intake manifold, there are two wire push clips (20) attached to the back. Using the clip lifter tool, remove them from the intake manifold.

Step 21: Remove the intake manifold.

NOTE: Be careful not to drop anything down the holes in the engine. Place something over the holes on the engine to protect yourself. Failure to do this could result in a damaged engine.



Figure L

Refer to Figure L for Steps 22-23

Step 22: Flip the intake manifold over so that you are looking at the seals.

Step 23: Using a drift punch and a hammer, hit the ten (10) factory screws and spacers (21) out of the intake manifold.

**Figure M****Refer to Figure M for Steps 24-25**

Step 24: Place the two (2) supplied aFe Intake Manifold Spacers (22) on a work surface.

Step 25: Install the eight (8) supplied intake manifold seals (23) into the aFe Intake Manifold Spacers.

NOTE: Using a lubricant will help install the intake manifold seals into the aFe Intake Manifold Spacers.

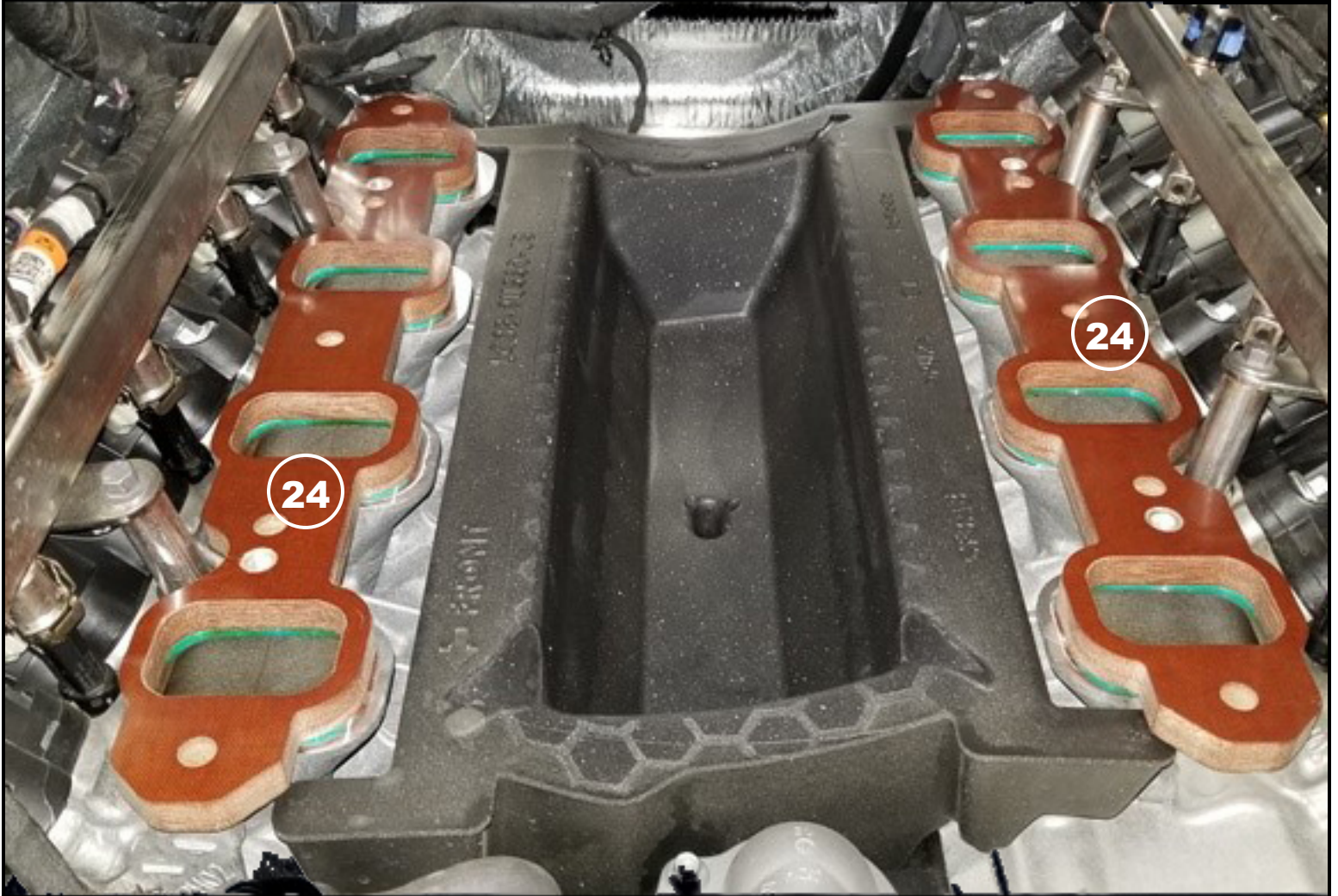

Figure N

Refer to Figure N for Step 26

NOTE: Using a lubricant will help install the aFe Intake Manifold Spacers onto the engine.

NOTE: If applicable, remove the coverings used to protect the engine. Be careful not to drop anything in the exposed holes on the engine.

Step 26: Install the aFe Intake Manifold Spacers (24) onto the engine.

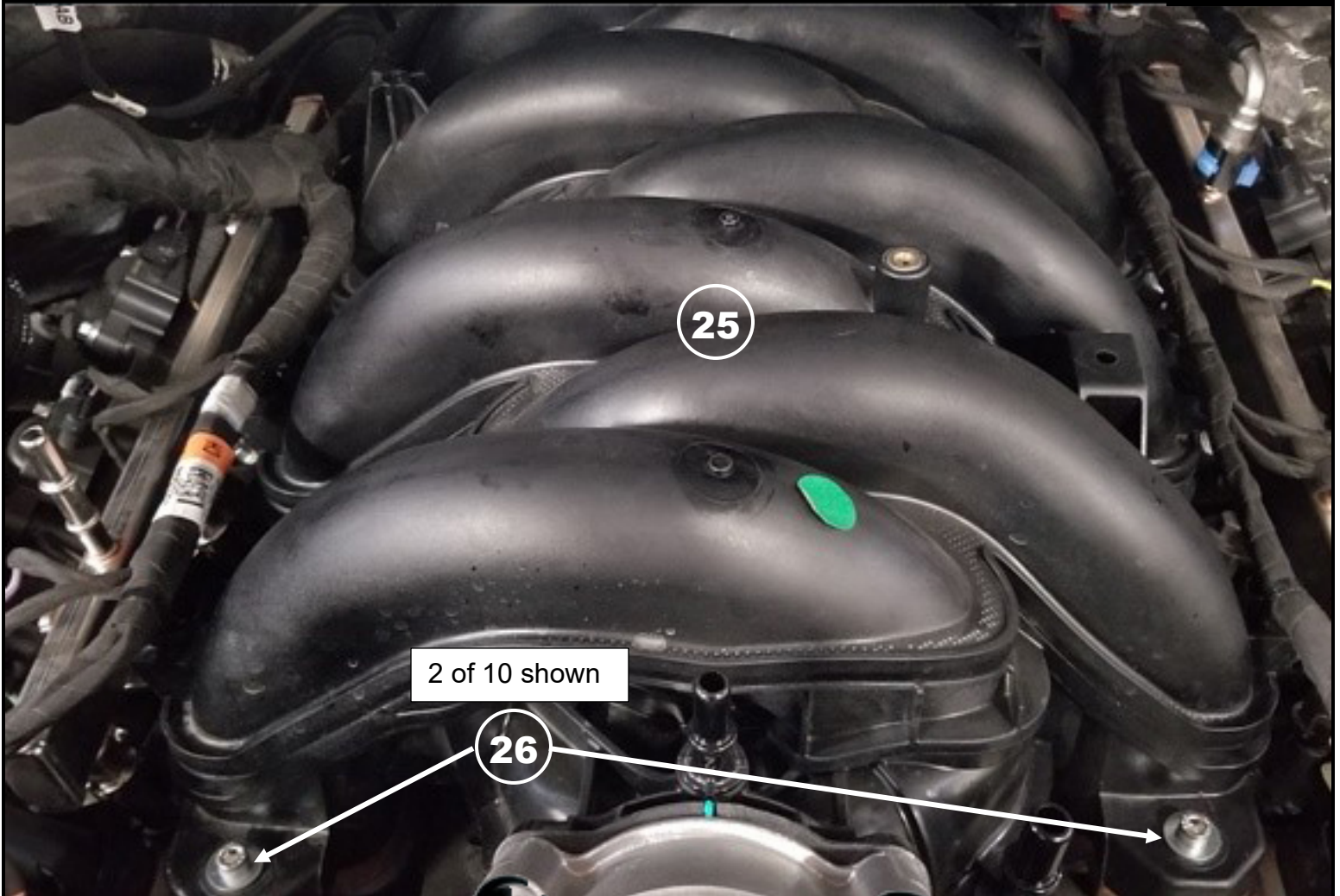
**Figure O****Refer to Figure O for Steps 27-29**

Step 27: Install the factory intake manifold (25) onto the aFe Intake Manifold Spacers.

Step 28: Install the ten (10) supplied aFe Intake Manifold Spacer sleeves (26). This will align the intake manifold to the aFe Intake Manifold Spacers.

Step 29: Install the ten (10) supplied M6 x 1.0 x 55mm socket head cap screws into the intake manifold. Leave loose at this time.

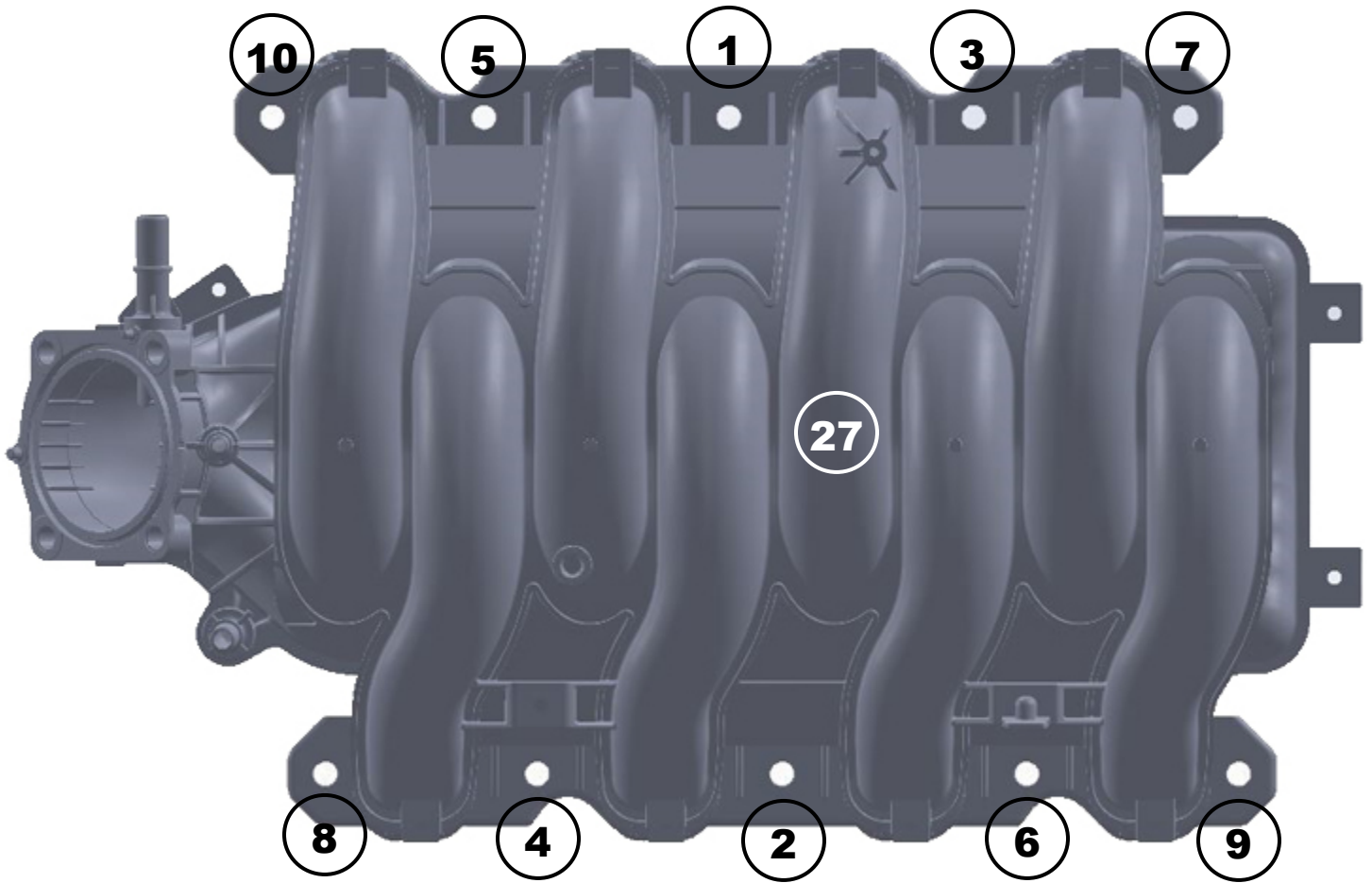
**Figure P****Refer to Figure P for Step 30**

Step 30: Tighten the intake manifold (27) down using the number sequence (1-10) shown above. Torque to 106 in. lbs. Go around again and torque the bolts to 120 in. lbs.

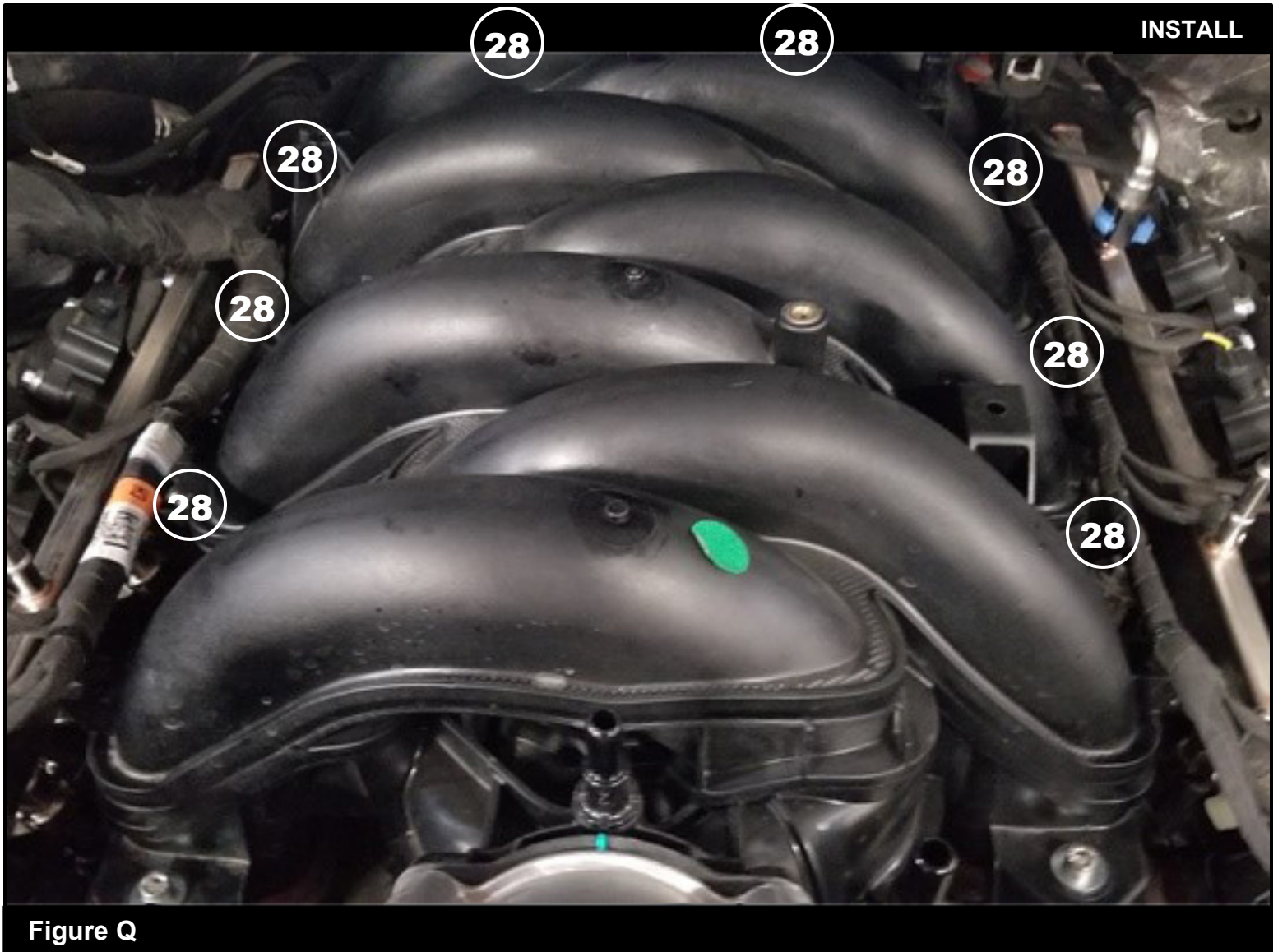

Figure Q

Refer to Figure Q for Step 31

Step 31: Carefully move the wiring loom for the coil packs and the fuel injectors back onto the intake manifold. Install the eight (8) push clips (28) in the holes they were removed from in Step 18 and Step 20.



Figure R

Refer to Figure R for Step 32

Step 32: Reinstall the push clip (29) below the throttle body remove in Step 17.

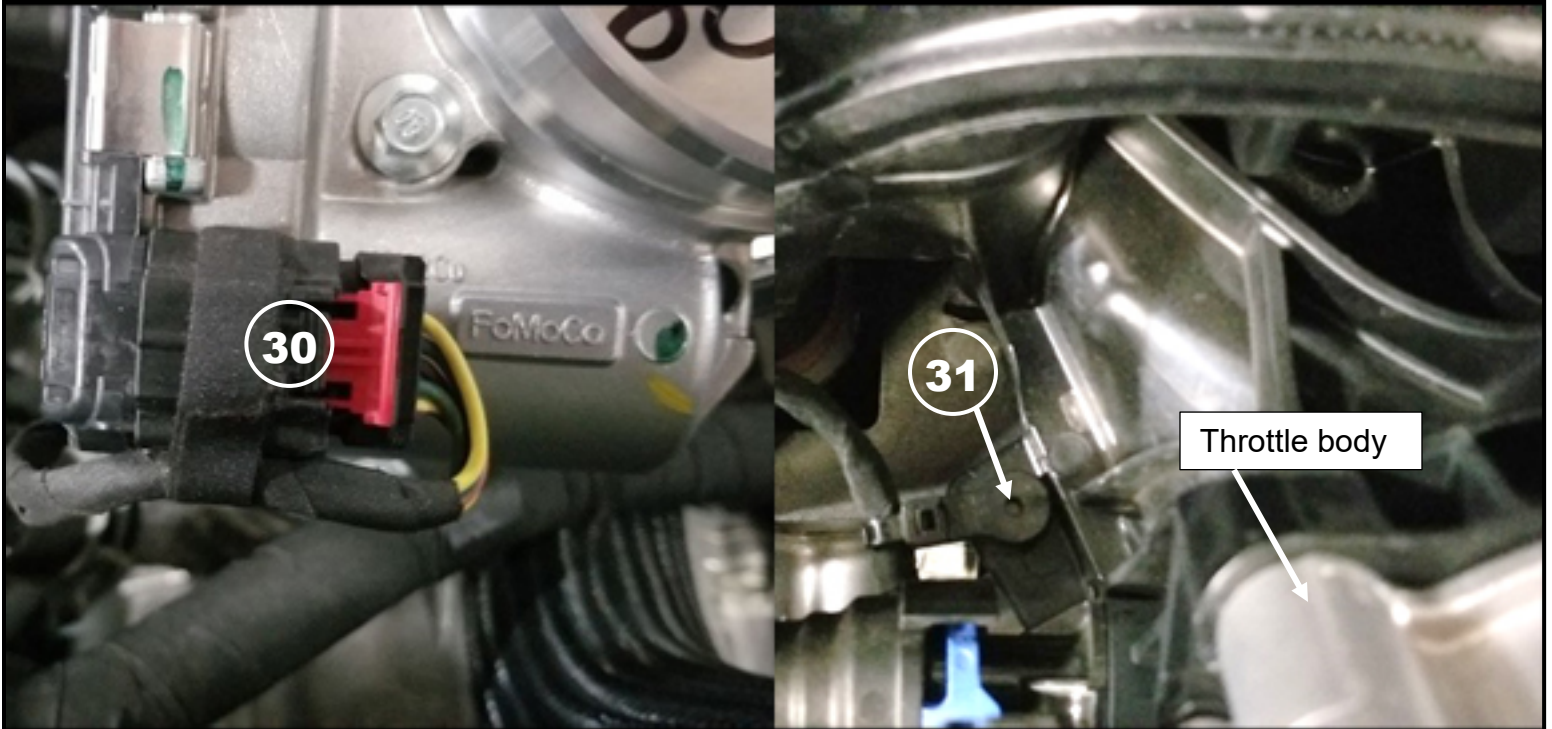

Figure S

Refer to Figure S for Step 33-34

Step 33: Reconnect the electrical connector (30) to the throttle body.

Step 34: Push the retaining clip (31) back into the intake manifold.

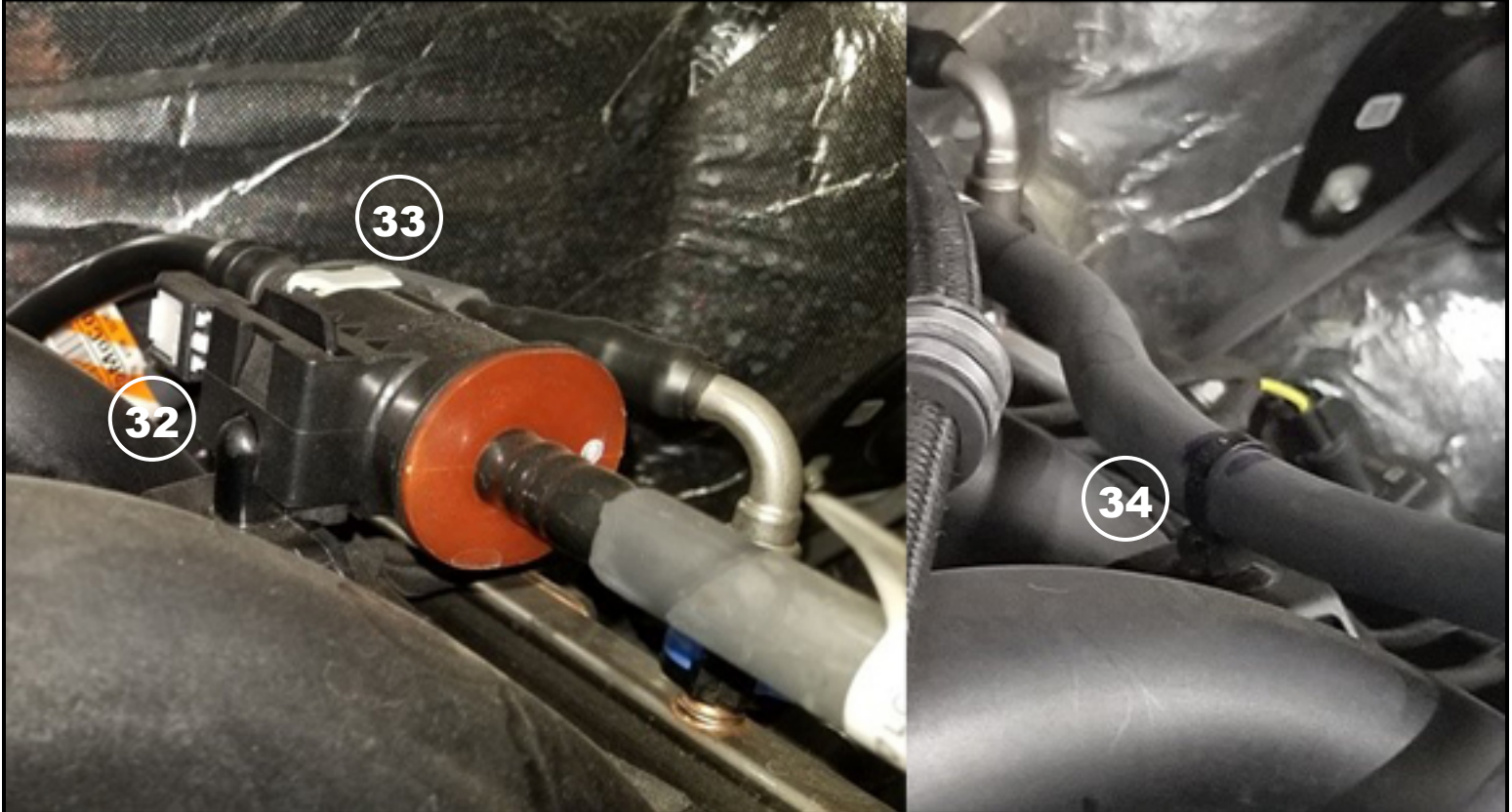

Figure T

Refer to Figure T for Steps 35-38

Step 35: Reinstall the fuel evaporative control solenoid back onto the intake manifold using some lubricant.

Step 36: Reconnect the electrical connector (32) to the fuel evaporative control solenoid.

Step 37: Reconnect the quick disconnect fitting (33) to the fuel evaporative control solenoid.

Step 38: Reinstall the push clip (34) which attaches the fuel evaporative control tube to the front of the intake manifold.

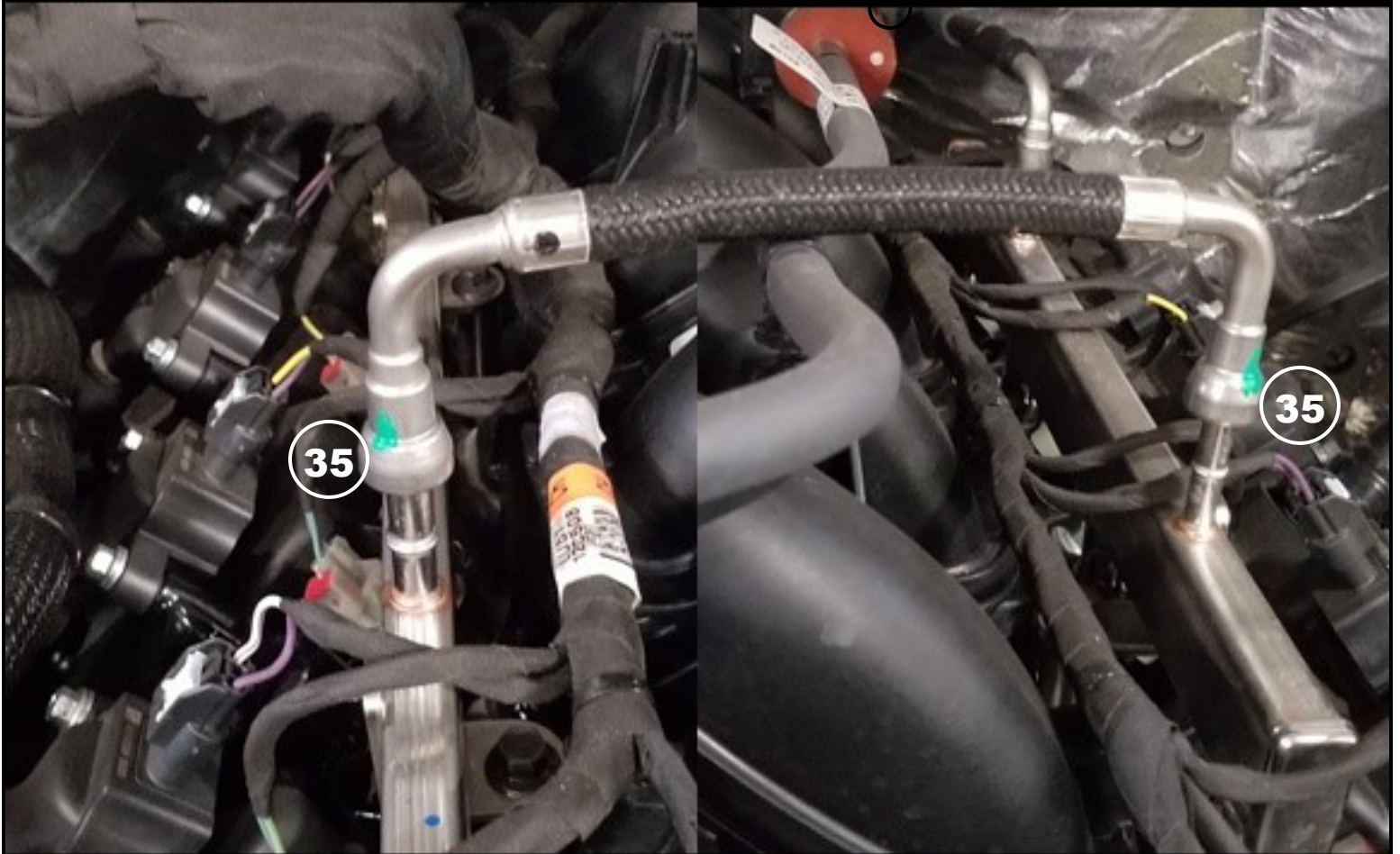

Figure U

Refer to Figure U for Steps 39-40

Step 39: Install the factory fuel line onto the quick disconnect fittings (35).

Step 40: Using a T-45 Torx bit, install the bolt removed in Step 10 that retains the fuel line to the top of the intake manifold.

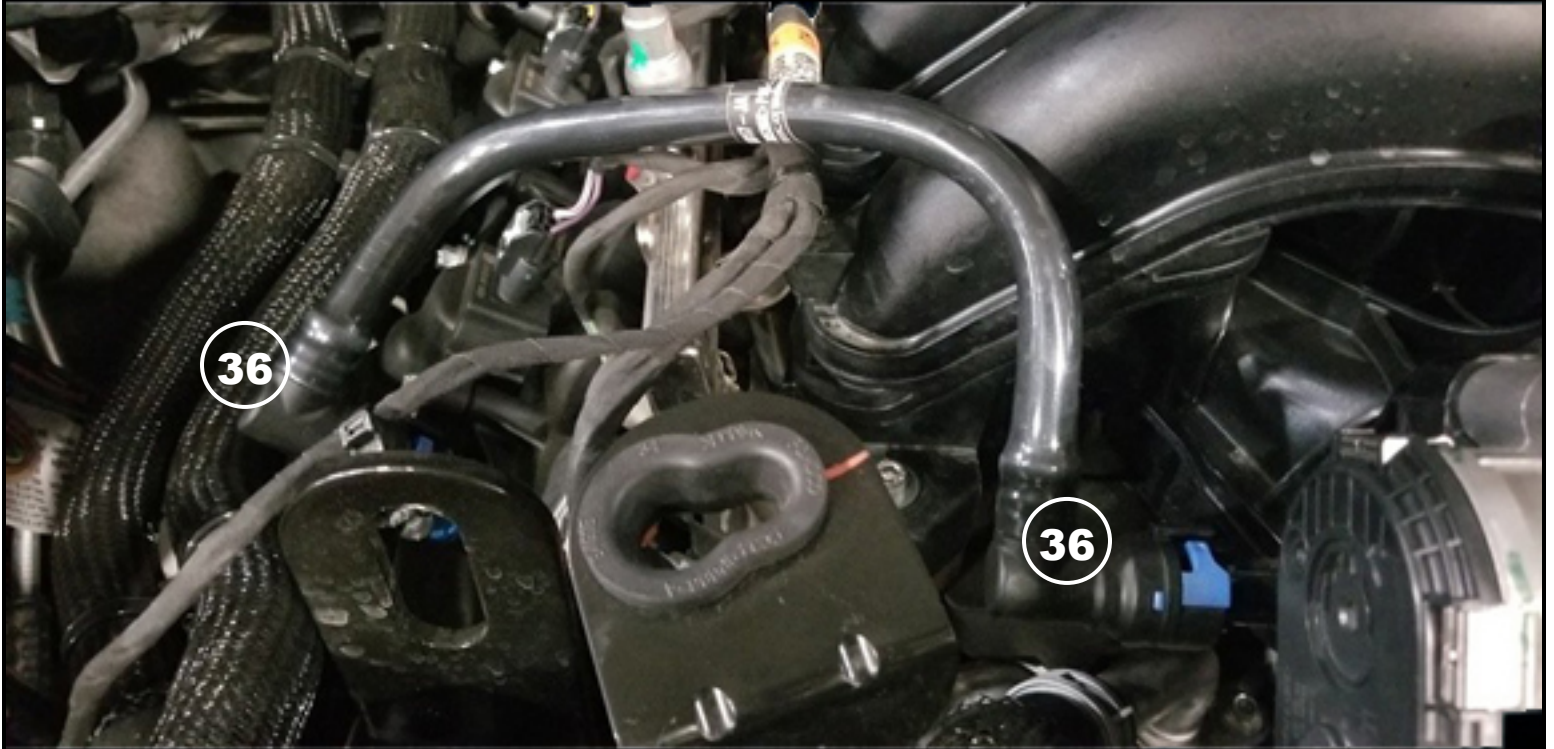

Figure V

Refer to Figure V for Step 41

Step 41: Reinstall the CCV tube by pushing the quick disconnect fittings (36) onto the male quick disconnect fittings behind the throttle body and on the valve cover.

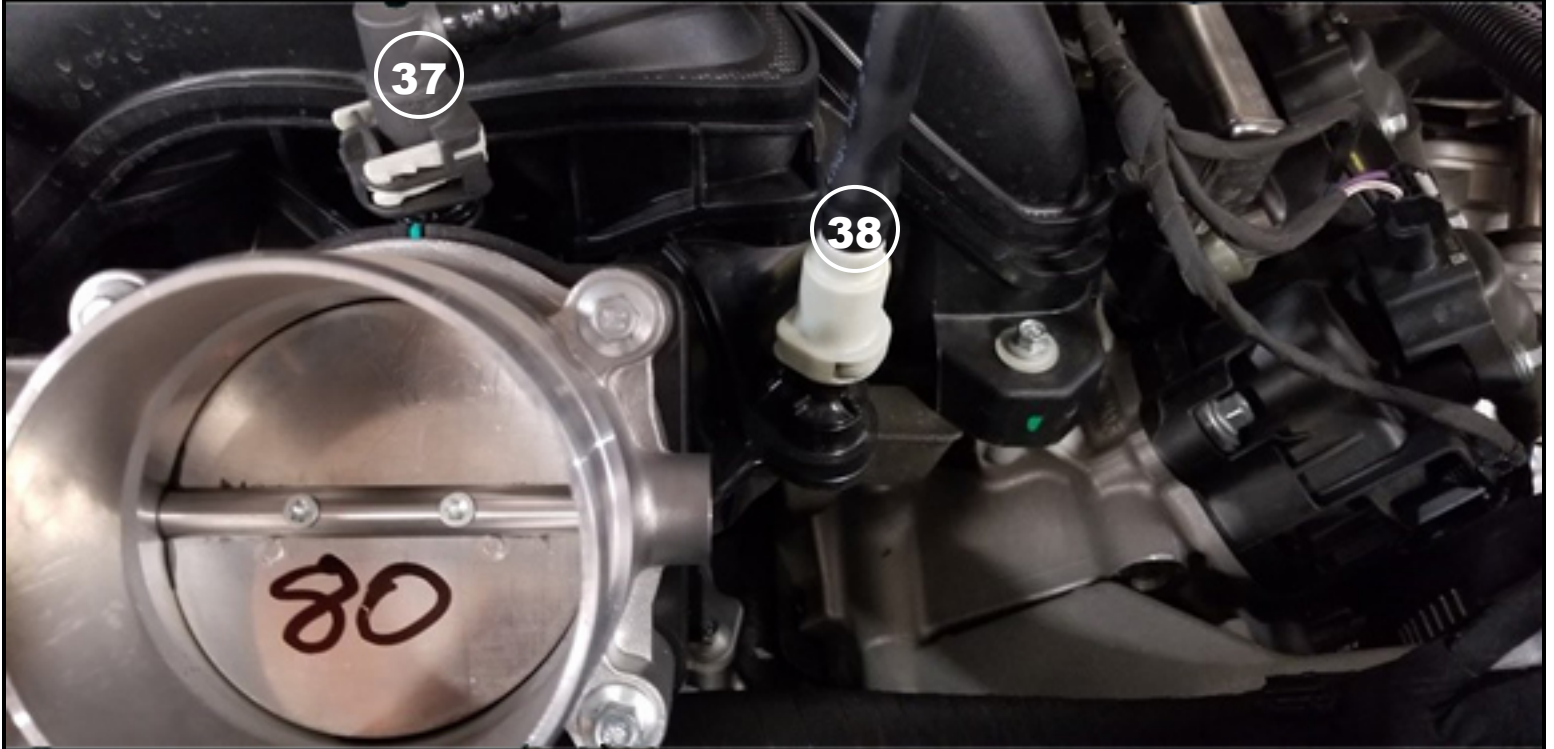

Figure W

Refer to Figure W for Step 42

Step 42: Reconnect the two (2) quick disconnect fittings (37) (38) to the male quick disconnect fittings on the intake manifold removed in Step 6.



Figure X

Refer to Figure X for Steps 43-47

Step 43: Reinstall the air filter system (39) back into the vehicle. Use a 7mm nut driver to tighten the clamp onto the throttle body. Reclip the air filter housing (40).

Step 44: Reconnect the two (2) quick disconnect fittings (41) back onto the intake tube that were removed in Step 2.

Step 45: Reconnect the mass air flow (MAF) sensor connector (42).

Step 46: Reconnect the battery wires (43).

Step 47: Installation is now complete.

NOTE: Check all screws, clamps, and connectors are secure after 100-200 miles.

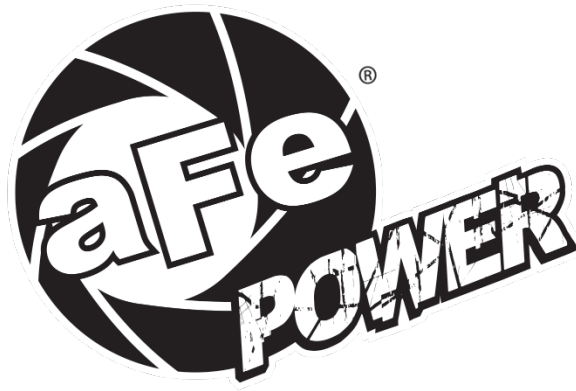

advanced FLOW engineering, inc.
Corona, CA 92879
<https://afepower.com/contact>