



INSTALLATION INSTRUCTIONS

MAKE: Chevrolet
MODEL: Corvette C8
YEAR: 2020-2023
ENGINE: V8-6.2L

Cat-Back Exhaust

49-34127NM-B

49-34127NM-C

49-34127NM-P

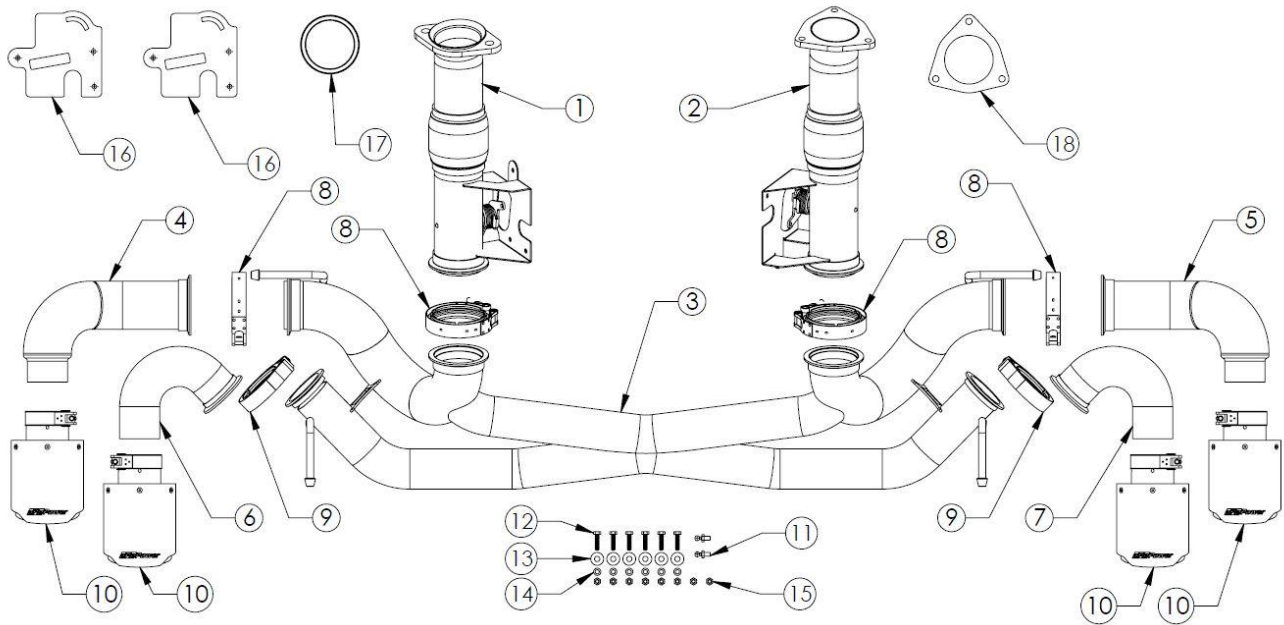

Item	Description	Part Number	Quantity
1	Left Front Pipe Assembly	05-245017	1
2	Right Front Pipe Assembly	05-245018	1
3	X-Pipe Assembly	05-245026	1
4	Left Outer Tail Pipe Assembly	05-245024	1
5	Right Outer Tail Pipe Assembly	05-245025	1
6	Left Inner Tail Pipe Assembly	05-245022	1
7	Right Inner Pipe Assembly	05-245023	1
8	3" V-Band Clamp	05-41588	4
9	2.5" V-Band Clamp	05-410196	2
10	Clamp-On Polished Tip 4-1/2"	49T25454-P071	4
10	Clamp-On Satin Black Tip 4-1/2"	49T25454-B072	4
10	Clamp-On Carbon Fiber Tip 4-1/2"	49T25454-C07	4
11	Ball Stud: 8mm, M6 x 1.00	03-50649	2
12	Screw, Hex Head: M6 x 1 x 25	03-50114	6
13	Washer, Flat: M6	03-50070	6
14	Washer, Lock: M6	03-50071	6
15	Nut, Hex: M6X1, Gr 8.8	03-50059	8
16	Plate, Doubler, Exhaust Valve	05-46451	2
17	Gasket, Left Exhaust Inlet: Corvette C8	05-46456	1
18	Gasket, Right Exhaust Inlet: Corvette C8	05-46457	1

aFe POWER recommends professional installation on this product. Thoroughly inspect the aFe POWER exhaust system to make sure there is no damage from shipping (if damage is noted, immediately contact aFe POWER customer service). Allow time for your vehicle to cool down prior to installation. When working on your vehicle proceed with caution. Wear protective safety equipment; eye goggles and gloves to ensure a safe installation.

Install band clamps to proper torque specifications of 40-45 ft-lb.

Install V-band clamps with anti-seize lubricant and hand tighten only to torque specifications of 10-15 ft-lb.



INSTALLATION INSTRUCTIONS

MAKE: Chevrolet
MODEL: Corvette C8
YEAR: 2020-2022
ENGINE: V8-6.2L

Cat-Back Exhaust

49-34127NM-B
49-34127NM-C
49-34127NM-P

1. **(Read instructions prior to installation.)** It is recommended to not fully tighten the exhaust until it has been fully installed. Leave loose for adjustability.
2. Secure vehicle on jack stands (refer to your manual for specified jack stand positions).
3. For faster installation, spread out the parts of the exhaust alongside your vehicle as shown in the diagram above.
4. Remove the 14 screws at top of bumper, and 2 screws in each top corner near taillights.
5. Remove both rear wheels.
6. Remove the rear inner fender liners by removing the 17 screws per side and clips securing the inner fender liners.
7. Remove the 10 screws securing the rear undertray and remove the rear undertray.
8. Slide the bumper rearward, to provide clearance to the three electrical connectors between the bumper and the chassis.
9. Unplug the three electrical connectors and remove the rear bumper.
10. Remove the two T-top rests on the inside of the trunk, four bolts per side.
11. Remove the trunk carpet.
12. Remove the 10 screws securing the airbox access panel and remove the airbox access panel.
13. Remove the two air inlet ducts connecting the airbox to the chassis, four bolts per side.
14. Unclip the two O2 sensor connectors from the rear of the airbox.
15. Unplug the temperature sensor at top of airbox.
16. Unplug the MAF sensor and loosen the hose clamp connecting the airbox to the throttle body coupling.
17. Remove the transaxle breather from the airbox.
18. Remove the four bolts securing the airbox and remove the airbox.
19. Remove the two nuts securing the exhaust to the catalytic converter on the left side.
20. Remove the three bolts securing the exhaust to the catalytic converter on the right side.
21. Unplug the two front and two rear exhaust valves.
22. Remove the front isolators from the exhaust system.
23. Unbolt the rear exhaust hangers from the chassis (two bolts per side) and remove the exhaust system.
24. Remove the isolators and hangers from the OE exhaust system and transfer them to the aFe POWER X-Pipe assembly.

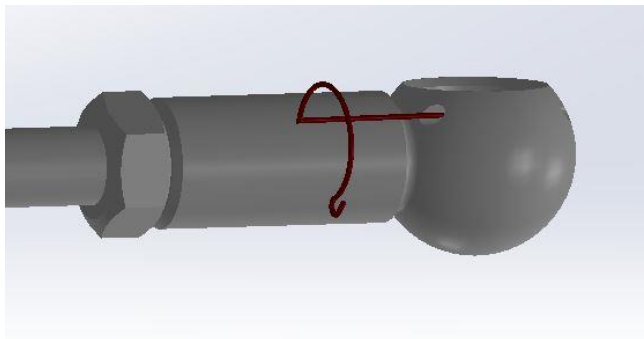

25. Remove the locking wire securing the front exhaust valve linkages to the exhaust valve with a pick or small screwdriver (See Image). Retain for later use.
26. Remove the front exhaust valve motors from the OE Exhaust.
27. Install the Ball Studs onto the exhaust valves on the aFe POWER Front Pipe Assemblies.
28. Install the OE Exhaust Valve motors onto the aFe power front pipe assemblies using the Doubler Plates and hardware provided.

NOTE: Before installing the valve linkage, assure that the exhaust valve is moving freely. If the valve is dragging, loosen the exhaust valve hardware and adjust the Doubler Plate to eliminate dragging.

29. Clip the OE valve linkage over the ball stud and reinstall the locking wires to retain the linkage
30. Replace existing gaskets with new gaskets provided in kit.
31. Install the Right Front pipe into the OE catalytic converter using the OE hardware.
32. Install the Left Front Pipe onto the OE Catalytic Converter using the OE hardware, do not fully tighten.



INSTALLATION INSTRUCTIONS

MAKE: Chevrolet
MODEL: Corvette C8
YEAR: 2020-2022
ENGINE: V8-6.2L

Cat-Back Exhaust

49-34127NM-B

49-34127NM-C

49-34127NM-P

33. Slide two 3" V-Band clamps over the aFe POWER X-Pipe Assembly.

34. Slide the X-Pipe Assembly into place and bolt the two rear hangers to the chassis

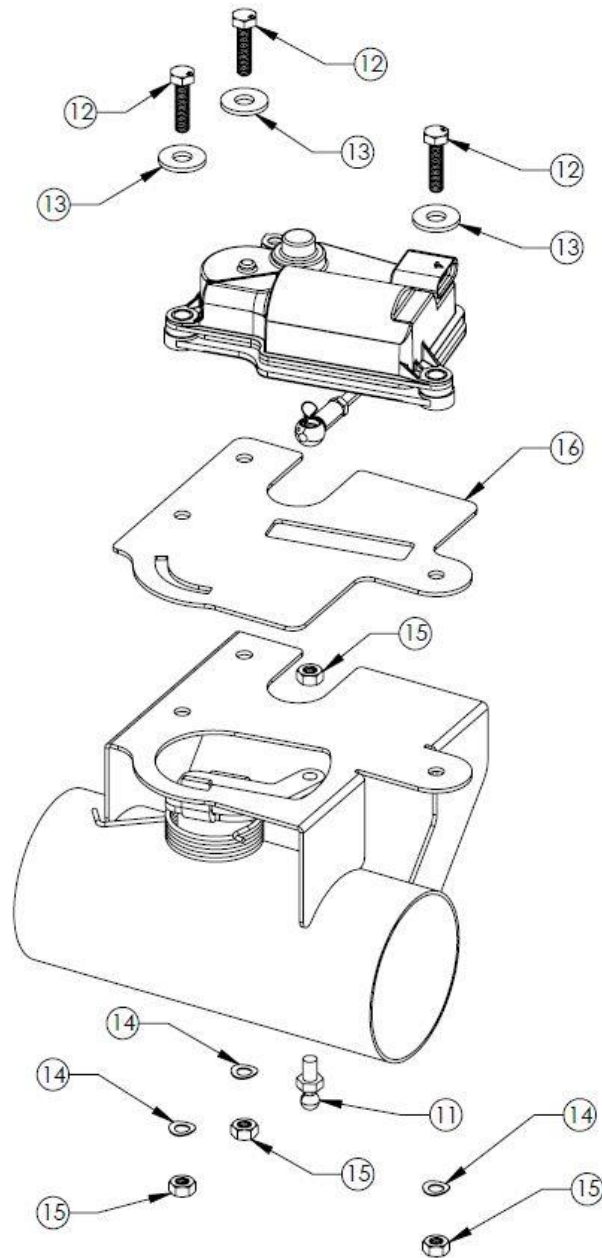

35. Assure the V-Band flanges from the front pipes to the X-Pipe Assembly are in alignment. You may need to rotate the left front pipe to align the flanges.

36. Install the Front Isolators onto the chassis.

37. Tighten the V-Band Clamps connecting the front pipes to the X-Pipe assembly.

38. Tighten the Left Front Pipe connection.

39. Plug the Exhaust Valve connectors into the front exhaust valves

40. Install the right and left inner tail pipes with the 2.5" V-Band Clamps.

41. Install the right and left outer tail pipes with the 3" V-Band Clamps.

42. Align the four Tail Pipes to be level to the ground.

43. Align the bumper to the rear of the vehicle and plug in the three connectors to the chassis.

44. Install the bumper onto the vehicle.

45. Install the screws at the top of the bumper.

46. Install the Exhaust Tips onto the tailpipes, Align the tips to the bumper.

47. Ensure that all the components of the aFe POWER exhaust system are aligned and are at a safe clearance from all wires, hoses, brake lines, body parts, and tires.

48. Start from the front of the aFe exhaust system and evenly tighten all clamps and fasteners.

49. Install the rear undertray.

50. Install the rear inner fender liners.

51. Install the airbox with the four OE bolts

52. Install the transaxle breather onto the airbox.

53. Plug in the MAF sensor and tighten the clamp from the airbox to the throttle body .

54. Plug the temperature sensor at the top of the airbox.

55. Attach the two O2 sensor connectors to the airbox

56. Install the two air inlet ducts from the airbox to the chassis.

57. Install the airbox access panel.

58. Install the truck carpet.

59. Install the two T-top rests on the inside of the trunk.

60. Install the rear wheels and torque lug nuts to 140 ft-lbs.

61. Start the vehicle and check for any leaks. If any leaks are found, determine cause and repair as necessary.

62. Remove vehicle from jacks stands.

63. It is recommended to re-tighten all clamps and hardware after 50-100 miles.



INSTALLATION INSTRUCTIONS

MAKE: Chevrolet
MODEL: Corvette C8
YEAR: 2020-2022
ENGINE: V8-6.2L

Cat-Back Exhaust

49-34127NM-B

49-34127NM-C

49-34127NM-P

