

# ROUGH COUNTRY

## SUSPENSION SYSTEMS®

### 2013-UP 3500 Dodge 5" Lift Kit SRW

**Thank you for choosing Rough Country Suspension for your Off Road needs.**

Rough Country recommends a certified technician installs this system. In addition to these instructions, professional knowledge of disassemble/reassembly procedures as well as post installation checks must be known. Attempts to install this system without this knowledge and expertise may jeopardize the integrity and/or operating safety of the vehicle. Average professional install time for this kit is 4-6 hours.

Please read all the instructions before beginning the installation. Check the kit hardware against the kit contents list on the last page. Be sure you have all the needed parts and understand where they go.

#### **▲WARNING**

#### **Product Use Information**

As a general rule, the taller a vehicle is the easier it will roll. We strongly recommend, because of roll-over possibility, that the vehicle be equipped with a functional roll-bar and cage system. Seat belts and should harnesses should be worn at all times. Avoid situations where a side rollover may occur.

Also check the steering stabilizer. It is a good idea when adding larger than stock tires to go with a larger bore steering stabilizer or a dual unit for tires 35" and above. Inspect the stabilizer and replace as necessary.

Braking performance and capability are decreased when significantly large/heavier tires and wheels are used. Take this into consideration while driving.

Do not add, alter, or fabricate any factory or after-market parts which increase vehicle height over the intended height of the Rough Country product purchased. Mixing component brands, lifts, and/or combining body lift with suspension lifts voids all warranties. Rough Country makes no claims regarding lifting devices and excludes any and all implied claims. We will not be responsible for any product that is altered.

#### **▲NOTICE**

This suspension system was developed for 37x12.50 tire on the stock 17" x 9" or 20" wheels at 5" of lift. On an aftermarket wheel you will need to purchase a 8" wide wheel with minimum of 4-5/8" of backspacing. When larger tires are installed, speedometer recalibration is necessary. Due to ride height inconsistencies from the factory you may need to slightly trim the front plastic valance for proper tire clearance.

This kit can also be used a 3500 single rear wheel truck. Use of this kit on a dual rear wheel pickup is not recommended. Block and u-bolt combinations may vary with 3500 models.

#### **▲NOTICE**

**On vehicles equipped with a two piece driveshaft & carrier bearing as on the Mega Cab, there is the potential for take off vibration, depending on the severity this can be corrected with shimming down the carrier bearing.**

**Carrier bearing drop kit Part # 1110 is available from Rough Country. Also 2500/3500 trucks with factory overload springs the overload will have to be removed for the new block and u-bolt installation.**

#### **▲NOTICE**

#### **Notice to Dealer and Vehicle Owner**

Any vehicle equipped with any Rough country product must have the "Warning to Driver" decal installed on the sun visor or dash. The decal is to act as a constant reminder for whoever is operating the vehicle of its unique handling characteristics. By purchasing any item sold by Rough Country, LLC, the buyer expressly warrants that he/she is in compliance with all applicable Federal, State, and Local laws and regulations regarding the purchase, ownership, and use of the item. It shall be the buyers responsibility to comply with all Federal, State and Local laws governing the sales of any items listed, illustrated or sold. The buyer expressly agrees to indemnify and hold harmless Rough Country, LLC for all claims resulting directly or indirectly from the purchase, ownership, or use of the items.

**INSTALLING DEALER—It is your responsibility to install the warning decal and to forward these installation instructions to the vehicle owner for review and to be kept in the vehicle for its service life.**



### Tools and Supplies Needed to Install Kit

1. Torque Wrenches	9. Pitman Arm Puller
2. ½" Drive Ratchet and Sockets	10. Hammers
3. Assorted Combination Wrenches	11. C-Clamps
4. Heavy Duty Jack Stands	12. Center Punch
5. Hydraulic Floor Jacks	13. 17/32" Drill Bit
6. Channel Locks	14. 9/16" Drill Bit
7. Anti-Seize Compound	15. 3/8" Drill Bit ( at least 6" long)
8. Drill Motor	16. 3/4" Drill Bit

### FRONT SUSPENSION INSTALLATION

1. Secure and block the rear tires of the vehicle on a level concrete or asphalt surface
2. Raise the front of the vehicle and support the frame with jack stands. Remove the front wheels and tires and set aside. Position a hydraulic jack under the front axle and raise the jack until the front suspension begins to compress
3. On both sides of the vehicle, scribe alignment marks on the adjustment cam and axle bracket at the lower axle bolt of the radius arm for later reference.
4. Unbolt the brake line brackets from the inside of the frame using a 13mm wrench to ensure brake line free play during the suspension system installation. **See Photo 1.** Retain stock hardware for later use.
5. Unplug the electrical connector for the four wheel drive engagement. **See Photo 2.**

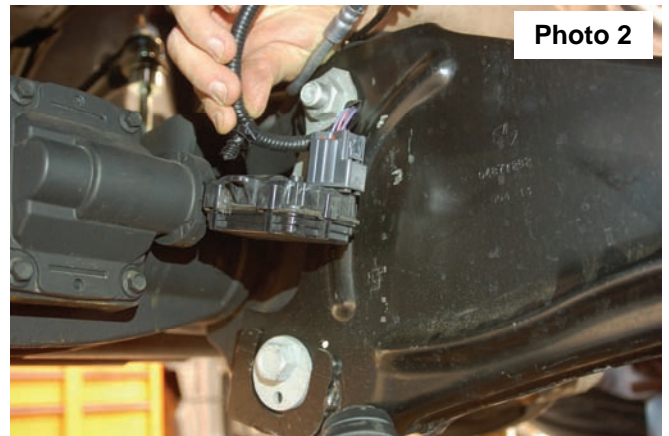
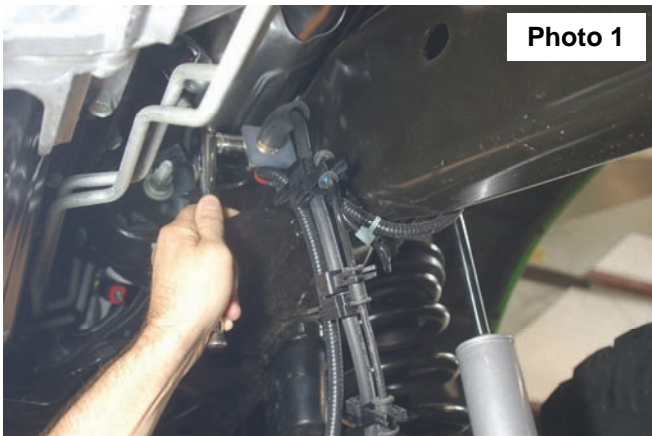

6. Remove the sway bar links by unbolting the lower sway bar nut as shown in **Photo 3** using a 10mm socket and a 21mm wrench.
7. Remove the track bar from its upper mounting point on the frame using a 1 1/16" wrench and rest it on the axle. It may be helpful to loosen the lower track bar bolt on the axle. Retain hardware for reuse.
8. Remove the cotter pin, and castle nut from the drag link where it connects to the pitman arm. A pitman arm tool may be needed to separate the drag link from the pitman arm. Remove the stock nut, and lock washer from the sector shaft on the steering box. Save hardware for later installation. Using a pitman arm puller carefully remove the stock pitman arm.
9. Remove the front shocks with a 18mm wrench for the upper stud and a 21mm socket for the lower bolt. **See Photo 4.** Retain lower shock mount factory hardware.

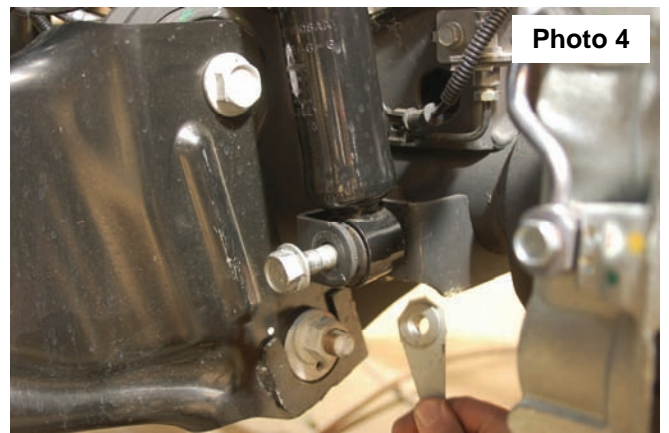
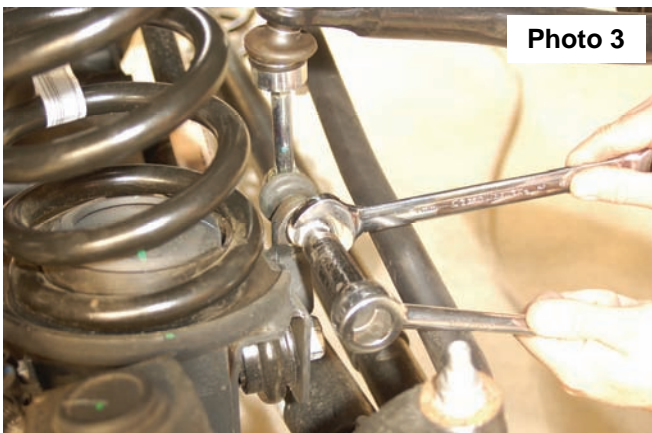

10. Lower the axle and remove the coil springs. Note there is a rubber push pin made on to the factory coil isolator to align the coil spring. Push on the top the pin to release the isolator from the frame coil pocket.
11. Using a 24mm socket and wrench remove the two bolt holding the driver radius arm to the axle. Retain factory hardware.
12. Next remove the radius arm bushing bolt with a 1 1/16" socket and wrench. Retain factory hardware.

13. Place drill template on factory radius arm mount, align factory hole and front edge. Mark and center punch new hole. Drill using a 3/4" drill. **See Photo 5.**
14. Using the factory bolt, bolt the supplied radius arm drop bracket into the factory mount. Mark and center punch the front hole on the bottom of the frame, using the new bracket as a guide. **See Photo 6.**

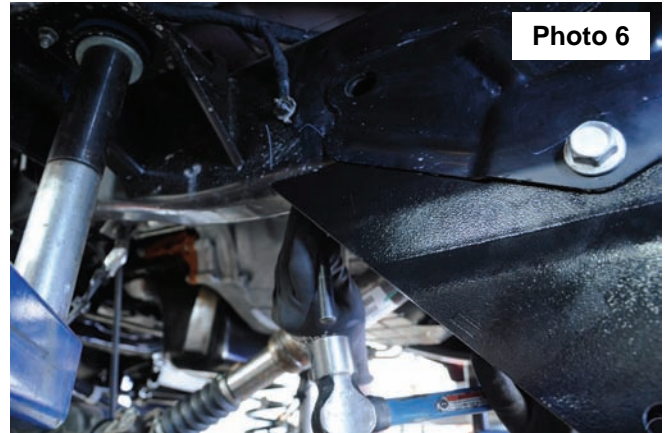
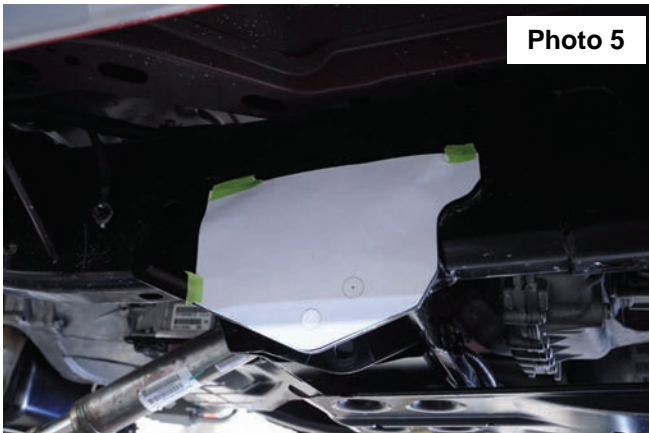

15. Remove the radius arm drop bracket and drill using a 9/16" drill. **See Photo 7.**
16. Using the factory hardware in the original hole and the supplied 3/4" x 1.5" bolt and washer, install the radius arm drop bracket into the factory radius arm mount. **See Photo 8.**

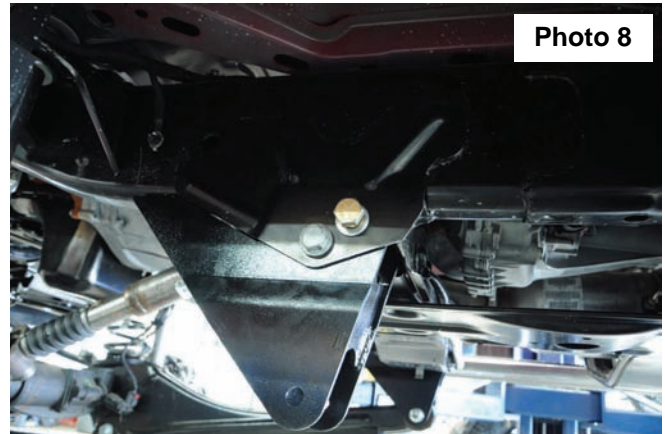

17. Insert the supplied flag nut into the bottom of the frame through the slotted hole. Attach the front of the bracket using the supplied 1/2" x 1.5" bolt and washer. Tighten using a 3/4" socket. Torque to 57ft-lbs. **See Photo 9.**
18. Install the factory radius arm using the factory hardware in the front and the supplied 18mm x 130mm" bolt, washer, and nuts in the rear mount. Torque to factory specs. **See Photo 10.**

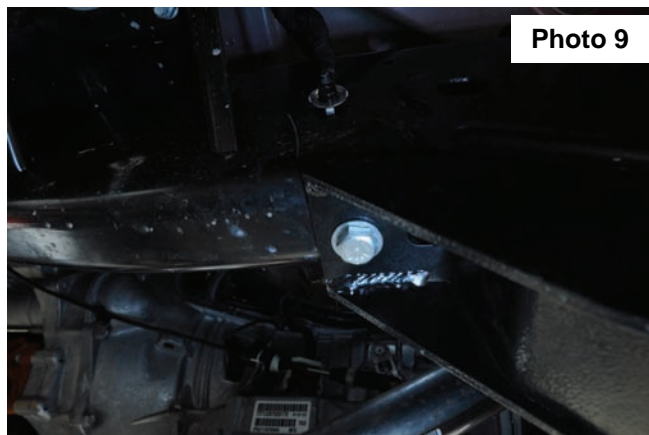

19. Repeat steps 4-18 on the passenger side.
20. Insert the coil spacer retainer in the coil pocket from the bottom side. Make sure the nut is facing down. **See Photo 11.** Using the 3/8" x 1.5 bolt and washer, bolt the coil spacer into the coil pocket. Align the rear hole up with the existing alignment hole in the tower before tightening the center bolt
21. Use the supplied 3/8" x 1.25" bolt, washer, and nut to bolt the spacer to the existing hole. **See Photo 12.**



22. The front hole will have to be drilled with a 3/8" long drill bit. **See Photo 13.** Then use the supplied 3/8" x 1.25" bolts, washers, and nuts to tighten. The front hole can be marked and then remove the spacer from the coil pocket. This will allow you to use a shorter drill bit.
23. Place the coil spring isolator on the bottom of the coil spring spacer and align the push pin in the rear hole directly below the factory hole in the coil pocket. **See Photo 14.** Next install the factory coil springs.

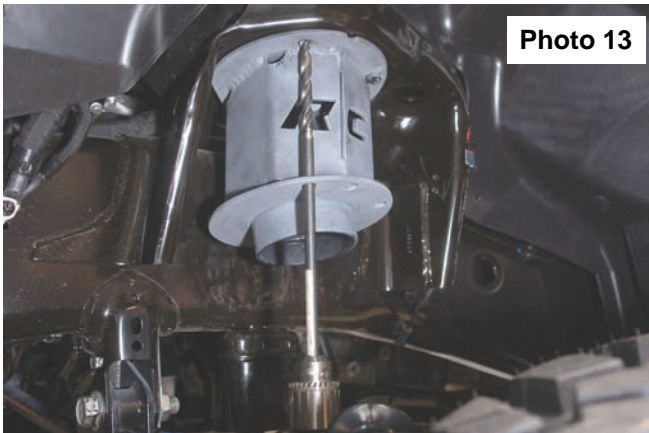

24. Install the new front shocks using the supplied bushings for the top mount and using factory hardware for the lower mount. Tighten the upper mount with a 18mm wrench and the lower mount with a 21mm socket.
25. Remove the factory bump stop and replace it with the new supplied longer bump stop. **See Photo 15.**

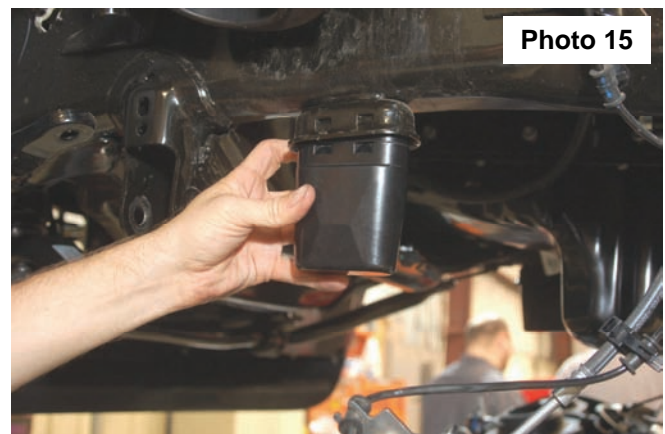

26. Install the new pitman arm into the stock location on the sector shaft, using stock hardware and torque to 185 ft. lbs.
27. Remove the pitman arm ball joint from the steering link. The flat will need to be cut off so you can rotate the ball joint for the new pitman arm. **See Photo 16.** Install the steering link ball joint onto the pitman arm using stock hardware.
28. Install the new supplied track bar bracket with the factory bolt. Hand tighten. Swing the bracket up to the cross member and mark the hole location for the support bolt, then remove the bracket. Drill the marked hole with a 17/32 drill bit. **\*Note\*** be careful not to drill into the oil pan. Place a block of wood or steel plate between the oil pan and the cross member. Install the track bar bracket and tighten factory bolt with a 1 1/16" socket and tighten the 1/2" x 1.25" bolt with a 19mm socket and wrench. **See Photo 17.** The bolt should be installed from the bottom.

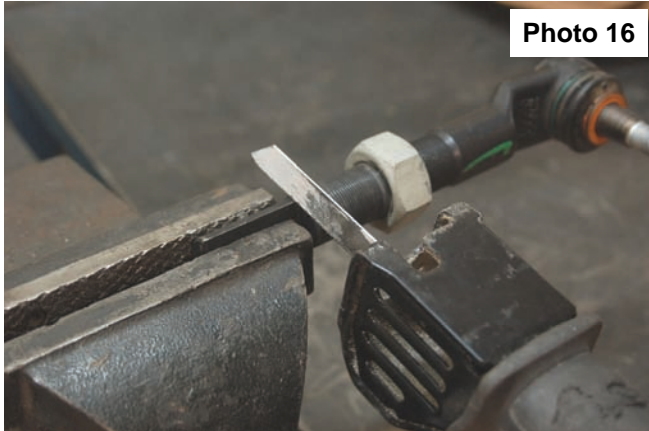

Photo 16

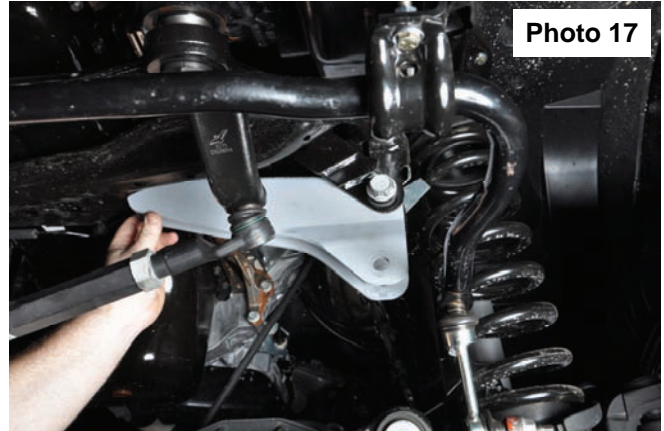

Photo 17

29. The track rod will be installed into the new mount after the vehicle is on the ground.
30. Remove the sway bar hardware using a 18mm wrench as shown in **Photo 18** and allow the sway bar to separate from the frame.
31. Install the sway bar drop bracket and secure to the frame using the factory hardware. Tighten with a 18mm wrench.
32. Install the sway bar to the new bracket with the supplied 7/16" x 1 1/4" bolts, flat washers and nuts. **See Photo 19.** Tighten using a 9/16" socket and wrench.



Photo 18

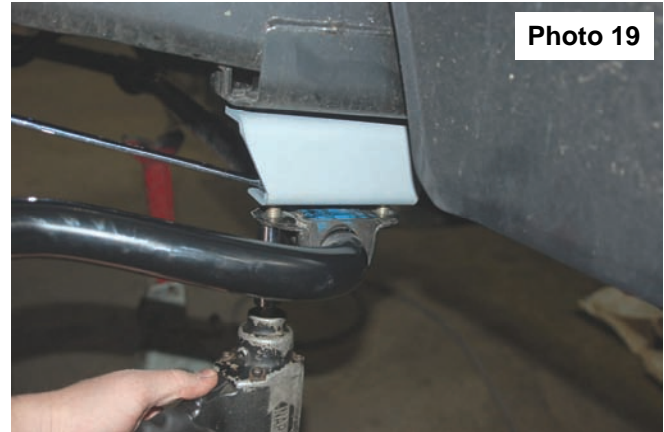

Photo 19

33. Install the front brake line brackets to the frame using factory hardware. **See Photo 20.** Attach the brake line mount to the new bracket with the supplied 5/16" x 3/4" bolts, washer, and nuts. Tighten with a 13mm socket and wrench.
34. Install the tires / wheels and then lower the truck to the ground.
35. Install the track rod in the new bracket using the supplied 18mm x 80mm bolt, washers, and lock nut. Tighten using a 1 1/16" socket and wrench.
36. Tighten the radius arm bolt with a 1 1/16" socket.
37. Install supplied shocks, 658737 using factory lower hardware and supplied upper hardware.



Photo 20

## E-BRAKE EXTENSION INSTALLATION

1. Secure and block the front tires of the vehicle on a level concrete or asphalt surface.
2. Raise the rear of the vehicle and support the frame with jack stands. Remove the rear wheels and tires and set aside.
3. Un-couple the e-brake cable on the drivers side of the vehicle. **See Photo 1.**
4. Remove the cable from the body mount using pliers to release the cable clips as shown in **Photo 2**



5. Remove the cable and place the supplied drilling template in place, making sure the template has the new hole placed directly below factory hole. The template may be tapped in place. **See Photo 3.**
6. Drill the new hole as shown using a 9/16" drill bit. **See Photo 4.**

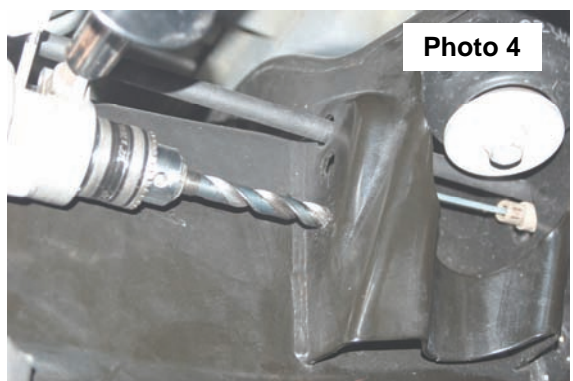

7. Install the e-brake line bracket on the e-brake line as shown in **Photo 5**, making sure the bracket snaps into place.
8. Install the supplied brake line bracket as shown in **Photo 6** with the supplied 1/2" x 1 1/2" bolts, flat washers and lock nut. Tighten using a 19mm wrench / socket.



9. Install the supplied e-brake extension bracket as shown in **Photo 7.**

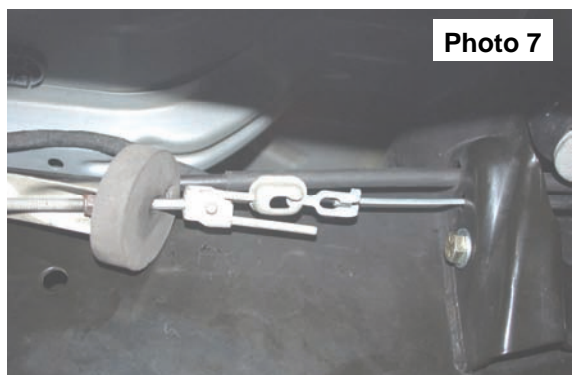

## REAR BLOCK INSTALLATION

1. Secure and block the front tires of the vehicle on a level concrete or asphalt surface.
2. Raise the rear of the vehicle and support the frame with jack stands. Remove the rear wheels and tires and set aside.
3. Place a floor jack under the center of the axle, and remove the stock u-bolts. Also remove the stock shocks.
4. Lower the axle down away from the springs, to allow clearance for the block. Make sure you do not overextend the brake lines.
5. Using C clamps, clamp on each side of the leaf pack and remove the two spring bolts using an 18mm socket as shown in **Photo 1**.
6. Remove the factory mini spring pack and bolts. **See Photo 2.**

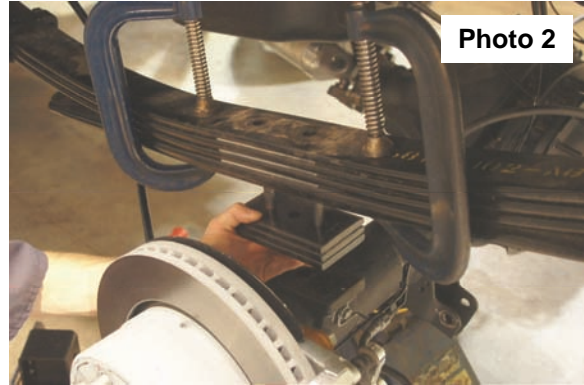
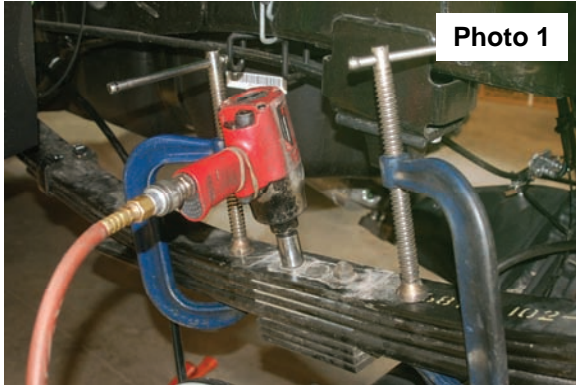

7. Install supplied 1/2" x 3" Allen head bolts and lock nuts. **See Photo 3.**
8. Tighten using a 3/4" socket and 3/8" Allen. **See Photo 4.**

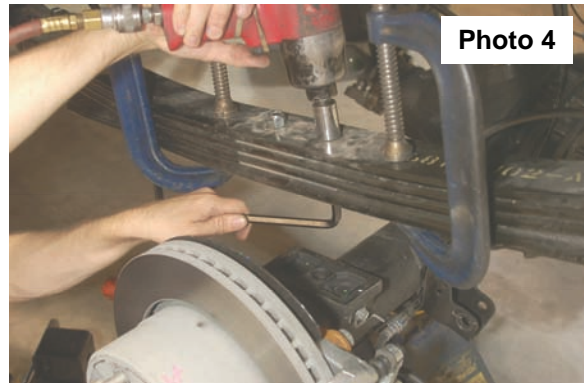
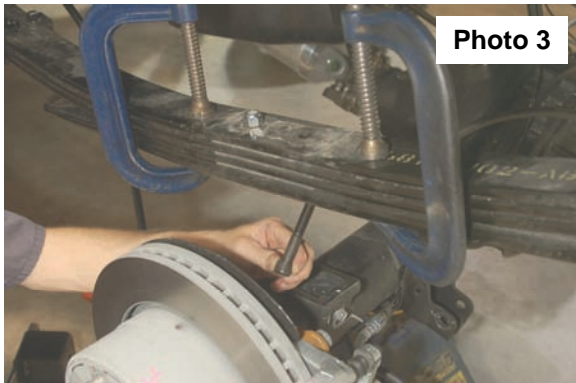

9. Remove C clamps and install supplied anti-wrap block and ubolts. Tighten using a 13/16" socket. Torque to 90 ft-lbs. **Larger end of the block will go toward the rear of the truck. See Photo 5.**
10. Install supplied anti-wrap ubolts, washers, and nuts as shown in **Photo 6**. Tighten using a 5/8" socket. Torque to 45 ft-lbs.

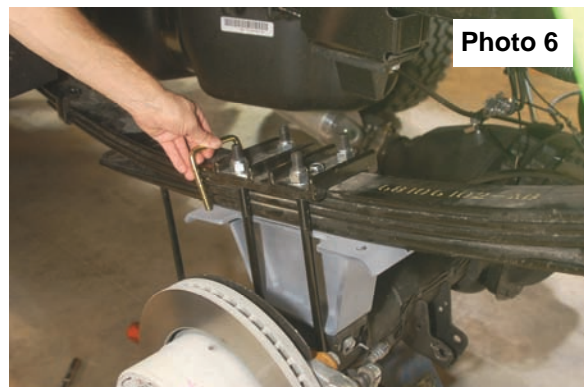
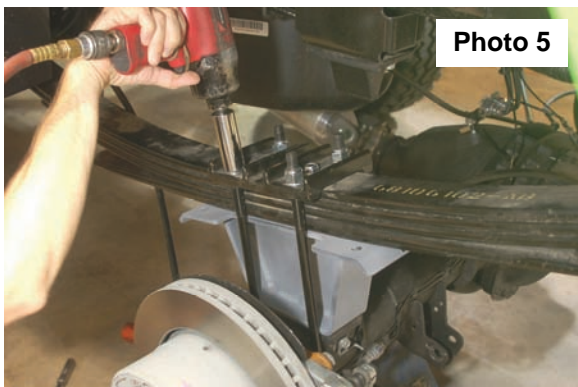

11. Assemble the new shock absorbers part # 658728 with bushings/sleeves and install on the vehicle.
12. Install the wheels / tires. Jack up the vehicle and remove the jack stands.
13. Lower the vehicle to the floor.



**Kit Contents:**

2-Coil Spring Spacers  
 1-Front Track Bar Bracket  
 2-Front Sway Bar Brackets  
 1-Pitman Arm (6615)  
 2-Rear Lift Block  
 4-Rear U-bolt  
 2-Front Shock Absorber (658737)  
 2-Rear Shock Absorber (658728)  
 1-Driver Radius Arm  
 1-Passenger Radius Arm

**Poly Bags:****1368Bag1:**

1-18mm Locknut  
 1-18mm X 80mm Bolt  
 1-18mm Washer  
 1-1/2" X 1.25" Bolt  
 1-1/2" x 1.5" Bolts  
 2-1/2" Washers  
 2-1/2" Lock Nut  
 4-3/8" Lock Washers  
 4-3/8" Nuts

2-3/8" x 1.5" Bolts  
 4-3/8 x 1.25" Bolts  
 4-3/8" Flat Washers  
 4-7/16" X 1 1/4" Bolt  
 4-7/16" Lock Nut  
 8-7/16" Flat Washer  
 2-5/16" x 3/4" Bolt  
 2-5/16" Lock Nut  
 2-5/16" Flat Washer

**1364Bag2:**

2-3/4" x 1.5" Bolts  
 2-3/4" Flat Washers  
 2-18mm x 130mm Bolts  
 4-18mm Flat Washers  
 2-18mm Nylock Nuts  
 2-1/2" x 1.5" Bolts  
 2-1/2" Flat Washers





Thank you for choosing Rough Country Suspension for your Off Road needs.

### DRILLING TEMPLATE

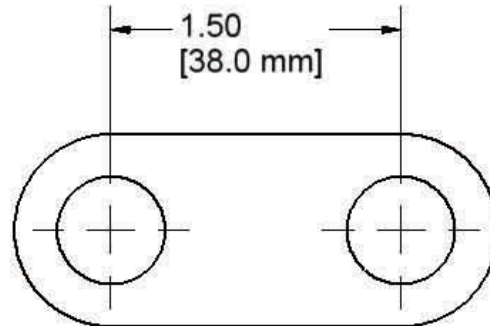

### POST INSTALLATION INSTRUCTIONS

Check all fasteners for proper torque. Check to ensure there is adequate clearance between all rotating, mobile, fixed and heated members. Check steering gear for interference and proper working order. Test brake system. Perform steering sweep. Check to ensure brake hoses have sufficient slack and will not contact rotating, mobile, or fixed members, adjust lines/brackets to eliminate interference and maintain proper working order. Failure to perform inspections may result in component failure.

Re-torque all fasteners after 500 miles. Visually inspect components and re-torque fasteners during routine vehicle service.

Readjust headlights to proper settings.

It is the buyer's responsibility to have all bolts/nuts checked for tightness after the first 100 miles and then every 1000 miles. Suspension components every 3000 miles.

By purchasing any item sold by Rough Country, LLC, the buyer expressly warrants that he/she is in compliance with all applicable Federal, State, and Local laws and regulations regarding the purchase, ownership, and use of the item. It shall be the buyers responsibility to comply with all Federal, State and Local laws governing the sales of any items listed, illustrated or sold. The buyer expressly agrees to indemnify and hold harmless Rough Country, LLC for all claims resulting directly or indirectly from the purchase, ownership, or use of the items.



