

ROUGH COUNTRY

SUSPENSION SYSTEMS®



1080BAG4

07-13 GM 1500 WINCH PLATE

THANK YOU FOR CHOOSING ROUGH COUNTRY FOR YOUR OFF ROAD NEEDS.

Rough Country recommends a certified technician install this kit. In addition to these instructions, professional knowledge of disassemble/reassembly procedures as well as post installation checks must be known. Attempts to install this kit without this knowledge and expertise may jeopardize the integrity and/or operating safety of the vehicle.

Please read instructions before beginning installation. Check the kit hardware against the parts list. Be sure you have all needed parts and know where they go. Also please review tools needed list and make sure you have needed tools.

▲ NOTICE There are different steps for GMC and Chevrolet trucks in this instruction sheet.

PRODUCT USE INFORMATION

Install winch with instructions supplied with winch. Always practice safe winching and recovery. Never overload a winch or use the winch which in any way would void your manufactures warranty.

Tools Needed:

10mm wrench /socket
 18mm wrench /socket
 21mm wrench
 5/16" Wrench
 7/16" Socket & Wrench
 3/4" Wrench
 Needle Nose Pliers
 Flat Screw Driver
 9/32" Drill
 7/16" Drill

Reciprocating Saw

Or
 Body Saw

Kit Contents:

Contains:

Winch Plate
 Driver Winch Plate Bracket
 Passenger Winch Plate Bracket
 License Plate Bracket
 Disengage Extension

1080 Poly Bag:

8-1/2" x 1.5" Bolts
 16-1/2" Flat Washers
 8-1/2" Lock Nuts
 1/4" x 3/4" Socket Head Cap
 Screw



GMC Install Instructions

1. Disconnect the positive and negative cable from the battery and secure them out of the way.
2. If the truck has lower fog lights unplug the driver and passenger side at the connector. **See Photo 1.**
3. Using a 10mm wrench remove the factory bolt on each corner of the factory bumper. **See Photo 2.**

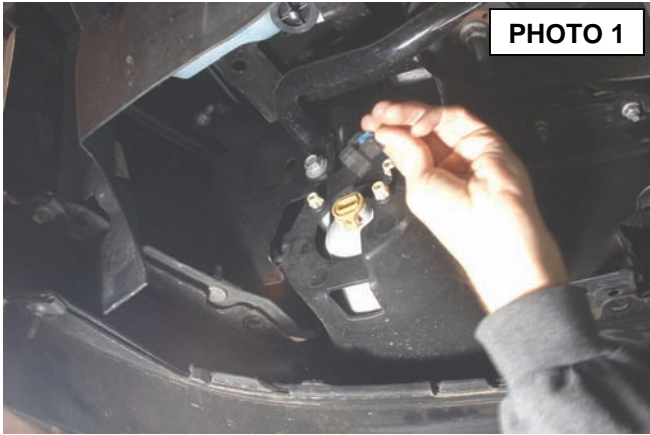

4. Remove the 16 push pins holding the lower valance to the front bumper. Use a flat screw driver or a small pair of pliers to pull out the center of the pin, Then the pin can be removed. After all the pins are removed lower the valance from the bumper. **See Photo 3.**
5. On the passenger side using a 21mm socket remove the two nuts from the bumper bolts on the outside of the frame rail. Pull the two bolts out of the frame. **See Photo 4.**



6. Insert the two bolts from the outside of the frame rail, making the nuts be on the inside of the frame. Next use a 18mm wrench to remove the nut from the tow hook bolt. **See Photo 5.**
7. Place the passenger side winch plate bracket on the three frame bolts and hand tighten the nuts. **See Photo 6.**

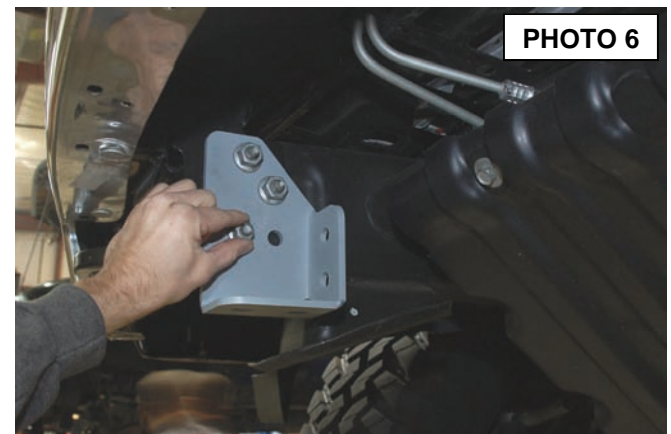

8. Repeat steps 5-7 on the driver to install the driver winch plate mount. **See Photo 7.**
9. Mount the winch to the winch plate using the hardware and instructions that was supplied with your winch.
10. Raise the winch plate and align the mounting holes, use the 8 supplied 1/2" x 1.5" bolts, washers, and lock nuts. **See Photo 8.**
11. Using a 3/4" socket and wrench tighten the 1/2" bolts that holds the winch plate to the bracket.
12. Next center the bumper and tighten bumper bolts with a 21mm wrench. Now tighten the tow hook bolts using a 18mm socket and wrench.
13. Bolt the roller fair lead and license plate bracket (if state required) using the bolts supplied with your winch.

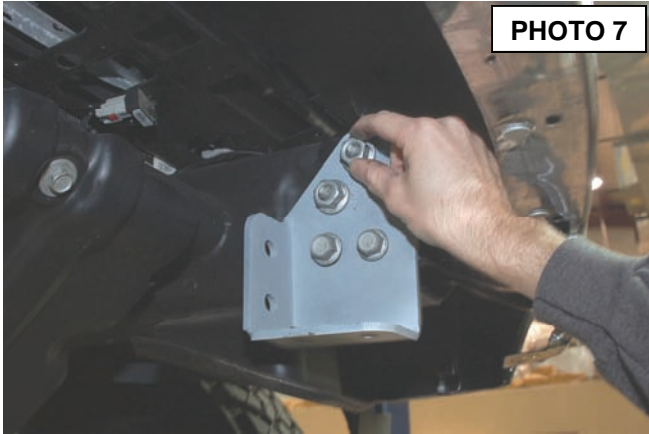

PHOTO 7



PHOTO 8

14. Use the supplied template to cut out the lower valance for the roller fairlead. **▲ NOTICE** there are two templates **one for Chevrolet trucks and one for GMC trucks located in the center page of the instructions. Cut out the two sides of the template and tape together.**
15. Place the correct template on the valance and secure with tape. **See Photo 9.**
16. Use a body saw or die grinder to cut out the pattern.
17. After you have cut out the lower valance, test fit the valance over the roller fairlead.
18. Before installing the valance run the wire the winch from the battery using the supplied instruction and hardware that was included with your winch. Attach the wire to the winch motor and tighten.
19. Install the valance to the bumper and push pin the 16 push pins in the factory locations.
20. Install and tighten the two corner outside valance bolts with a 10mm socket.
21. Plug in the electrical connectors to the lower fog lights if equipped on your truck.
22. Install the winch wire and factory battery connectors to battery.
23. Test winch to make sure everything is working properly.
24. If you do not have access through the bumper to the disengage handle on top of the winch refer to steps 17-22 of the Chevrolet install instructions for the winch handle extension installation.

GMC Template

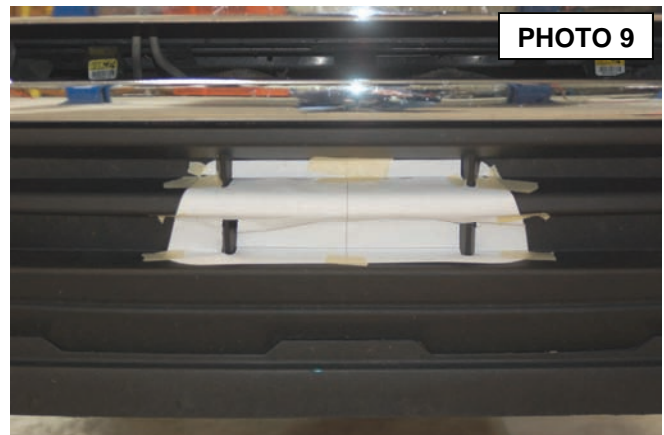
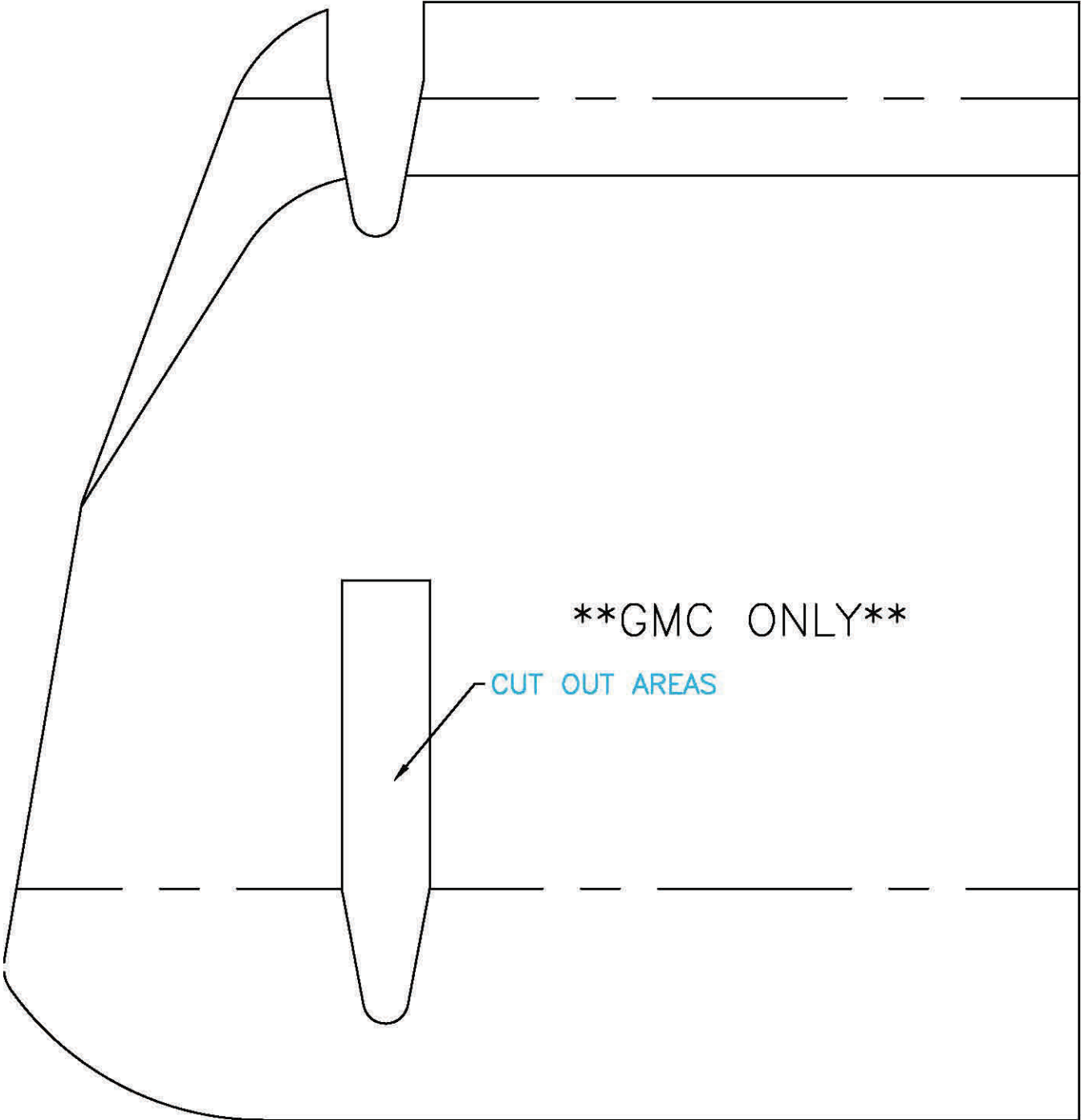
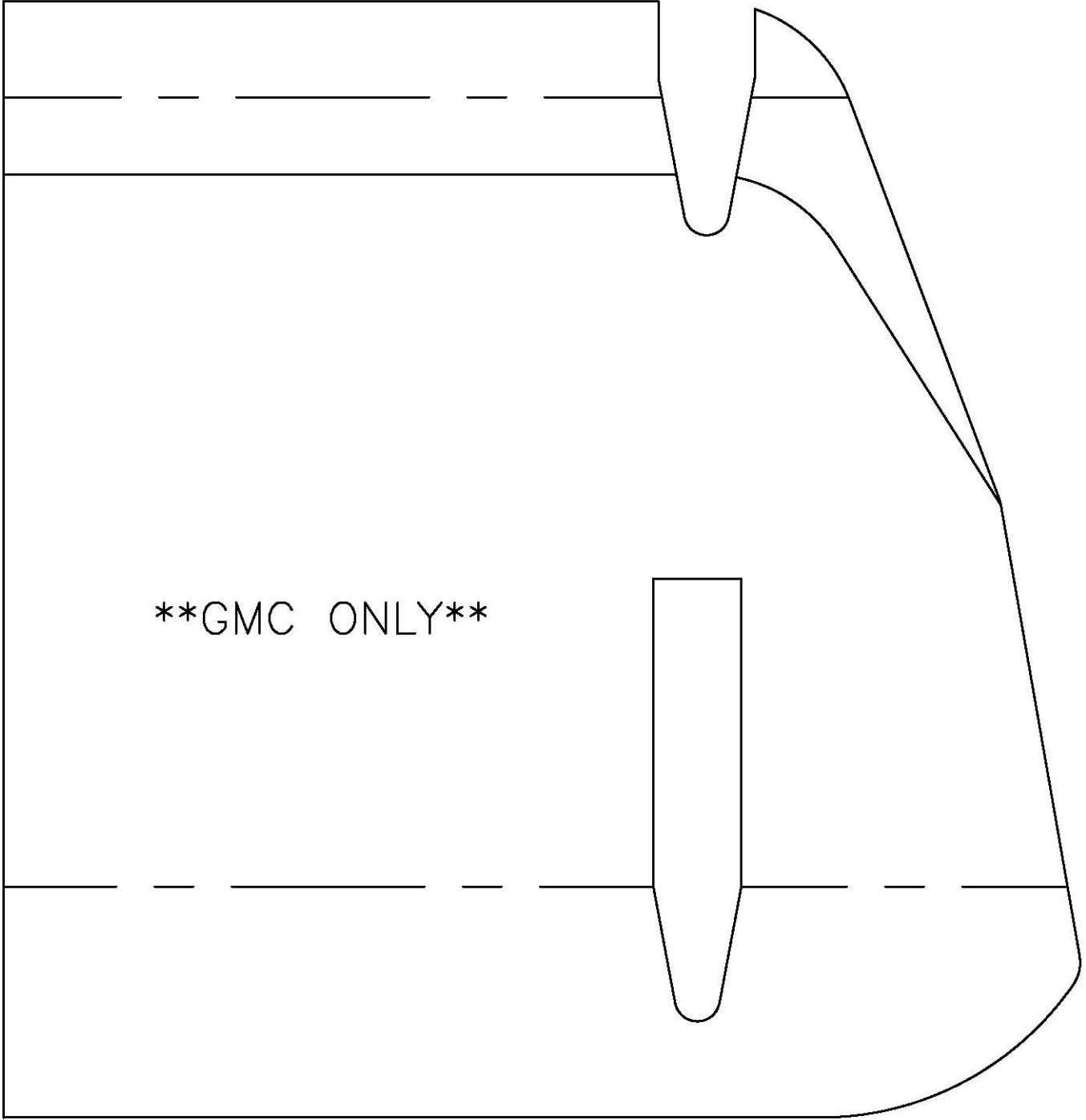

PHOTO 9



****GMC ONLY****

CUT OUT AREAS



****GMC ONLY****

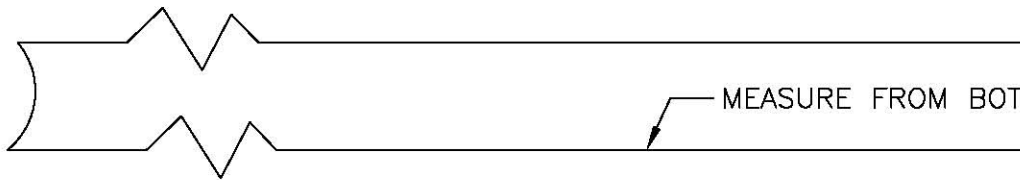

MEASURE FROM BOT

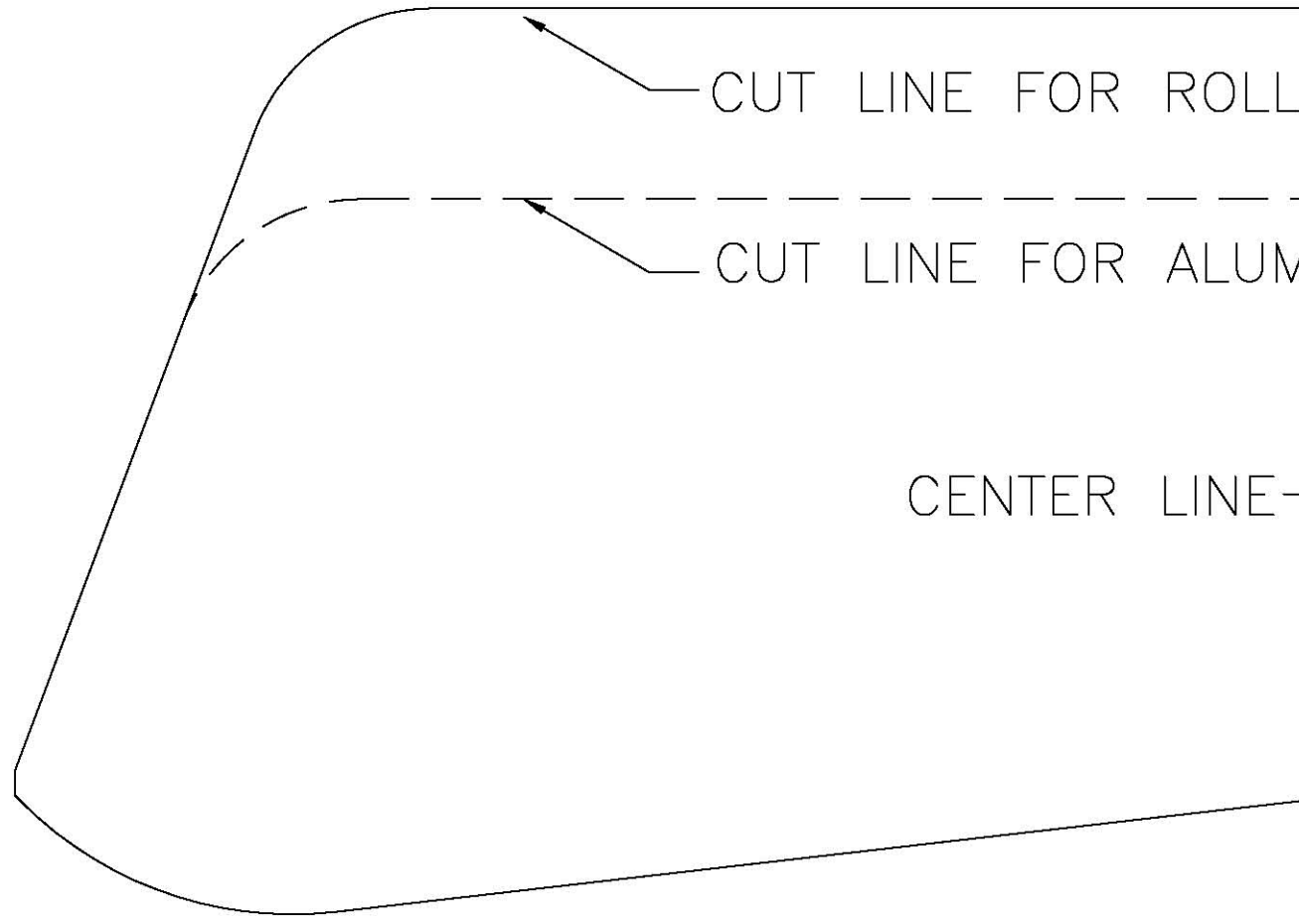

CUT LINE FOR ROLL

CUT LINE FOR ALUM

CENTER LINE-

TOM OF RADIUS AS SHOWN

1/4"

ER / CABLE FAIRLEAD

MINUM / ROPE FAIRLEAD

CHEVROLET ONLY

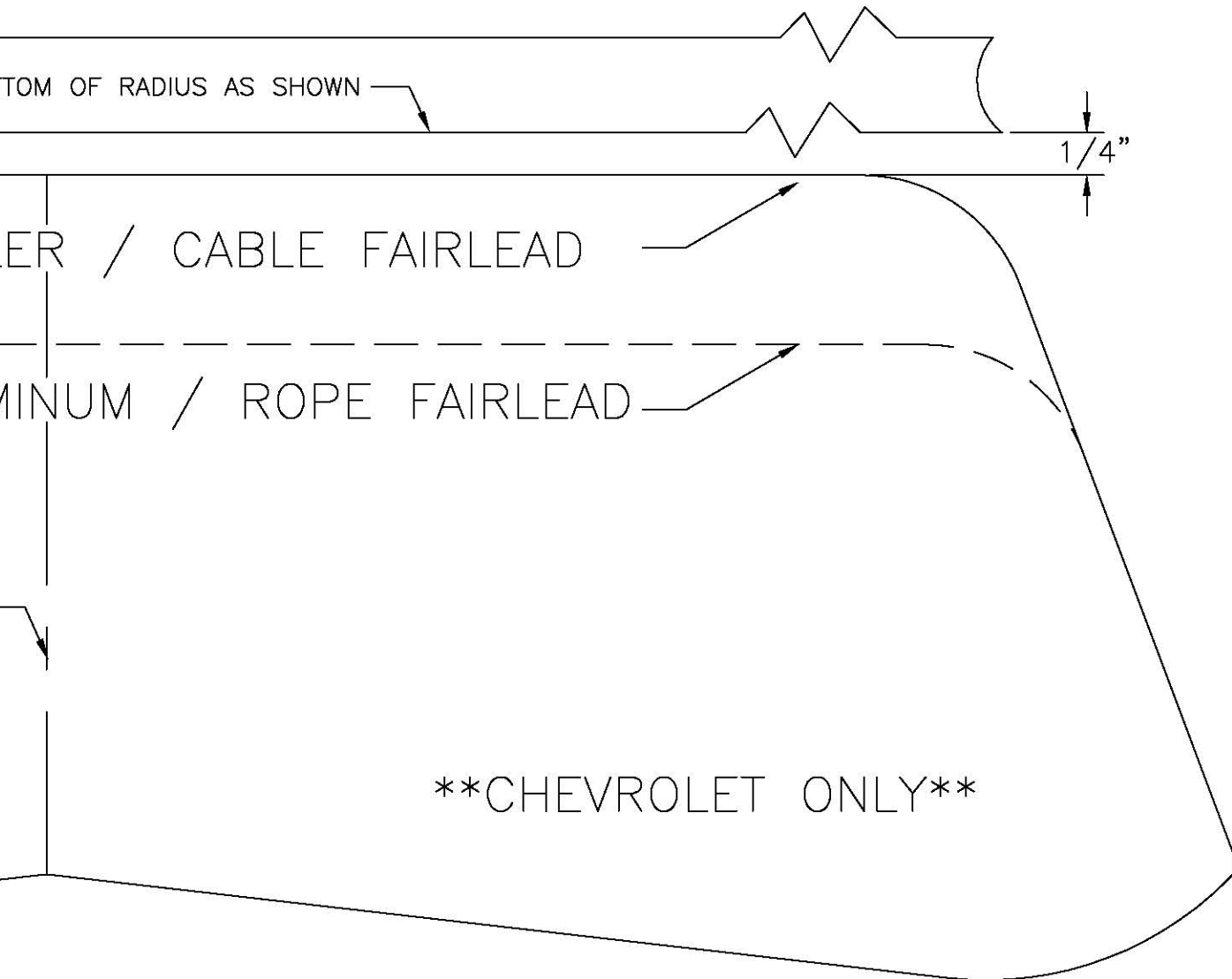

Chevrolet Install Instructions

1. Disconnect the positive and negative cable from the battery and secure them out of the way.
2. If the truck has lower fog lights unplug the driver and passenger side at the connector. **See Photo 1.**
3. Using a 15mm socket remove the bumper bracket bolt on the driver side. **See Photo 2.**



4. Remove the side support bolts with a 15mm socket. **See Photo 3.**
5. On the driver side using a 21mm socket remove the two nuts from the bumper bolts on the outside of the frame rail. Pull the two bolts out of the frame.
6. Next use a 18mm socket to remove the tow hook bolts.
7. Repeat steps 3-5 on the passenger side.
8. Reaching inside the bumper pull out the plastic clips holding the rubber splash guard to the bumper. **See Photo 4.**
8. Remove the bumper from the truck and set aside.



9. Remove the radiator shielding from the truck. **See Photo 5.** Use a flat head screw driver to pull out the plastic pins.
10. Next the grill shell will need to be removed, using a 10mm socket to remove the upper bolts of the grill assemble. **See Photo 6.**



11. Use a pair of needle nose pliers to hold in the tabs of the plastic clips so the grill shell can be removed. **See Photo 7.**
12. Using a 21mm socket remove the frame bracket from the bumper on the driver side. Slide the bracket over the frame horn and insert the factory bolts from the outside pointing in. Repeat on passenger side. **See Photo 8.**

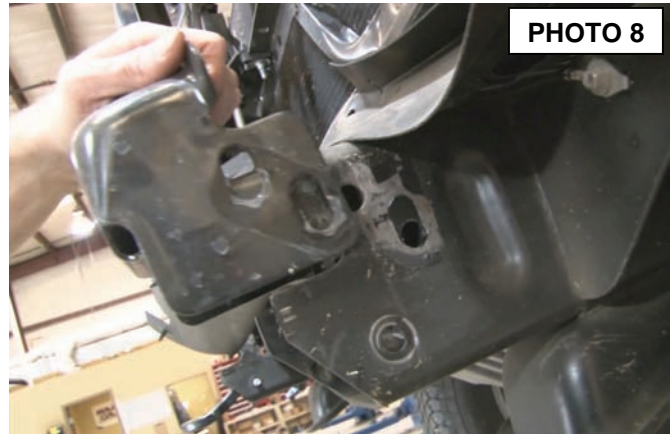

13. Place the driver side winch plate bracket on the three frame bolts and hand tighten the nuts. Insert the tow hook and secure with factory bolts. Hand tighten nuts. **See Photo 9.** Repeat on the passenger side.
14. Mount the winch to the winch plate using the hardware and instructions that was supplied with your winch.
15. Raise the winch plate and align the mounting holes, use the 8 supplied 1/2" x 1.5" bolts, washers, and lock nuts. Tighten with a 3/4" socket and wrench. Next tighten the bumper with a 21mm wrench and the tow hooks with a 18mm socket and wrench. **See Photo 9.**
16. Lay the rubber splash guard over the winch, using scissors cut the rubber so you can access the disengage handle and the winch wires.
17. If you do not have access through the bumper to the disengage handle on top of the winch. You will need to install the disengage ext. supplied with the kit. Place the extension over the winch handle and secure with the #10 x 1.5" long bolt, nylock nut and washers. Tighten with 5/16" wrenches. **See Photo 10.**

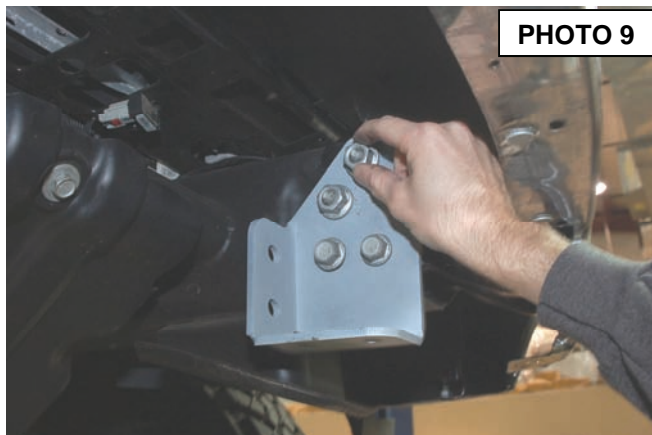

18. Install the handle ext. bracket using the factory grille mounting bolt. Drill into the radiator support with a 9/32" drill using the bracket as a guide. **See Photo 11.** Install the supplied 1/4" x 3/4" bolt, nylock nut and washer. **See Photo 12.**



19. Tighten the bolt using a 7/16" socket and wrench. **See Photo 13.**
20. On the radiator cover measure over 4 3/4" and mark. **See Photo 14.**



PHOTO 13

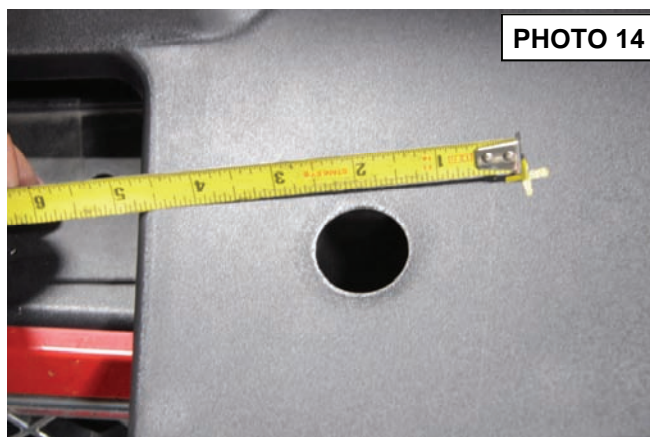

PHOTO 14

21. Measure from the front 3 1/4" and mark. **See Photo 15.**
22. Drill using a 7/16" drill . **See Photo 16.**



PHOTO 15

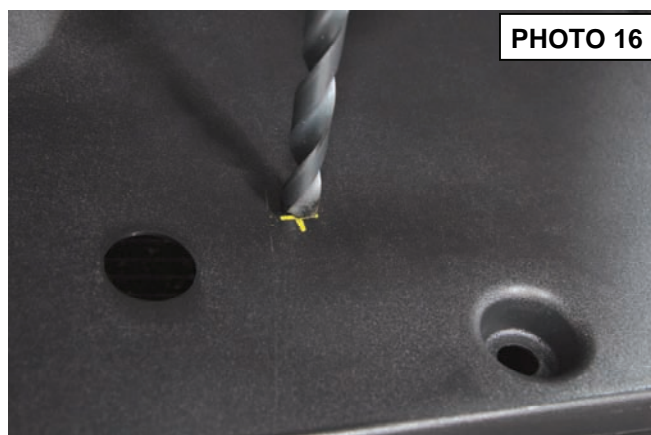

PHOTO 16

23. Use the supplied template to cut out the lower valance for the roller fairlead. **▲ NOTICE** there are two templates **one for Chevrolet trucks and one for GMC trucks. Make sure you are using the Chevrolet template.**
24. Remove the license plate mount on the factory bumper by cutting or grinding the aluminum rivets. Next secure template with tape. Use a body saw or die grinder to cut out the pattern. **See Photo 17.**
25. After you have cut out the lower valance, test fit the valance over the winch plate. **See Photo 18.**

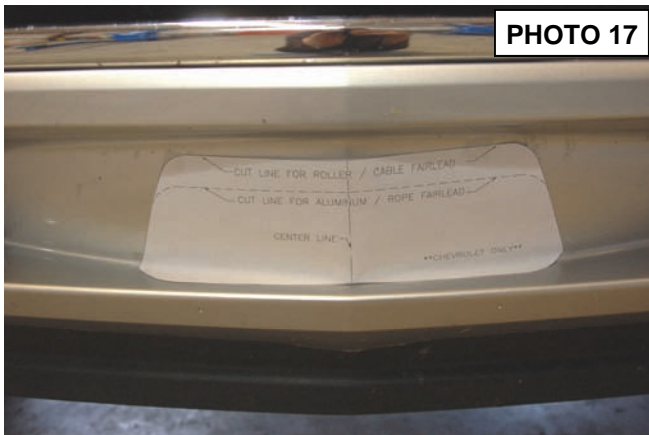

PHOTO 17



PHOTO 18

26. Before installing the bumper run the wire to the winch from the battery using the supplied instruction and hardware that was included with your winch. Attach the wire to the winch motor and tighten.
27. Install the bumper and top bumper bolts using a 21mm socket. **See Photo 19.**
28. Bolt the roller fair lead and license plate bracket (if state required) to the winch mount using the supplied hardware that was included with the winch.
29. Next attach the rubber splash guard to the bumper. **See Photo 20.**



PHOTO 19



PHOTO 20

30. Install the grill shell back into the truck and tighten the two upper factory bolts with a 10mm socket.
31. Tilt the rod back toward the motor of the truck and slide the plastic radiator shield over the rod through the new 7/16" hole you drilled. **See Photo 21.**
32. Align the holes in the plastic radiator shield and install the factory push pins. Push the center of the pin down to lock them in place. **See Photo 21.**
33. Install the winch wire and factory battery connectors to battery.
34. Test winch to make sure everything is working properly.



PHOTO 21

By purchasing any item sold by Rough Country, LLC, the buyer expressly warrants that he/she is in compliance with all applicable , State, and Local laws and regulations regarding the purchase, ownership, and use of the item. It shall be the buyers responsibility to comply with all Federal, State and Local laws governing the sales of any items listed, illustrated or sold. The buyer expressly agrees to indemnify and hold harmless Rough Country, LLC for all claims resulting directly or indirectly from the purchase, ownership, or use of the items.

