

# ROUGH COUNTRY

## SUSPENSION SYSTEMS®

### JEEP 2018-19 JL Front Inner Fenders

Thank you for choosing Rough Country for all your vehicle needs.

Please read instructions before beginning installation. Check the kit hardware against the kit contents shown below. Be sure you have all needed parts and know where they go.

If question exist, please call us @1-800-222-7023. We will be happy to answer any questions concerning this product.

Check all fasteners for proper torque. Check to ensure for adequate clearance between all components.

Check and retighten wheels at 50 miles and again at 500 miles. Periodically check all hardware for tightness.

#### TOOLS NEEDED:

4mm Allen  
8mm Socket  
10mm Wrench and Socket  
Jack  
Jack Stands  
Ratchet  
Body Saw  
Paint marker  
Tape measure  
Auto Trim Puller  
Long nose pliers  
Wheel Chocks

#### KIT CONTENTS:

Dr & Pass Outer Inner Fender  
Dr & Pass Rear Inner Fender  
Dr & Pass Front Bracket  
Dr & Pass RC logo plate  
Red Accents x2

#### HARDWARE INCLUDED:

(20) 6mm-1.0 x20 Button Head Bolts  
(8) 6mm-1.0 x20 Hex Head Bolts  
(2) 6mm-1.0 x35 Hex Head Bolts  
(12) 6mm Nylock Nut  
(18) 6mm Body clips  
(42) 6mm Flat Washers

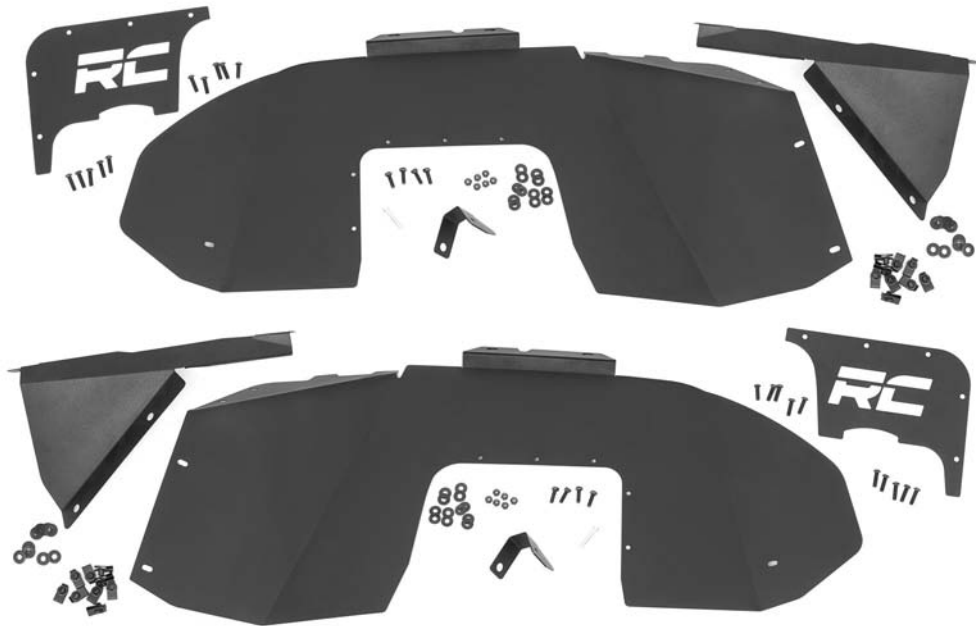

#### Torque Specs:

Size	Grade 5	Grade 8	Size	Class 8.8	Class 10.9
5/16"	15 ft/lbs	20ft/lbs	6MM	5ft/lbs	9ft/lbs
3/8"	30 ft/lbs	35ft/lbs	8MM	18ft/lbs	23ft/lbs
7/16"	45 ft/lbs	60ft/lbs	10MM	32ft/lbs	45ft/lbs
1/2"	65 ft/lbs	90ft/lbs	12MM	55ft/lbs	75ft/lbs
9/16"	95 ft/lbs	130ft/lbs	14MM	85ft/lbs	120ft/lbs
5/8"	135ft/lbs	175ft/lbs	16MM	130ft/lbs	165ft/lbs
3/4"	185ft/lbs	280ft/lbs	18MM	170ft/lbs	240ft/lbs



INSTALLATION INSTRUCTONS FOR STEP 32.

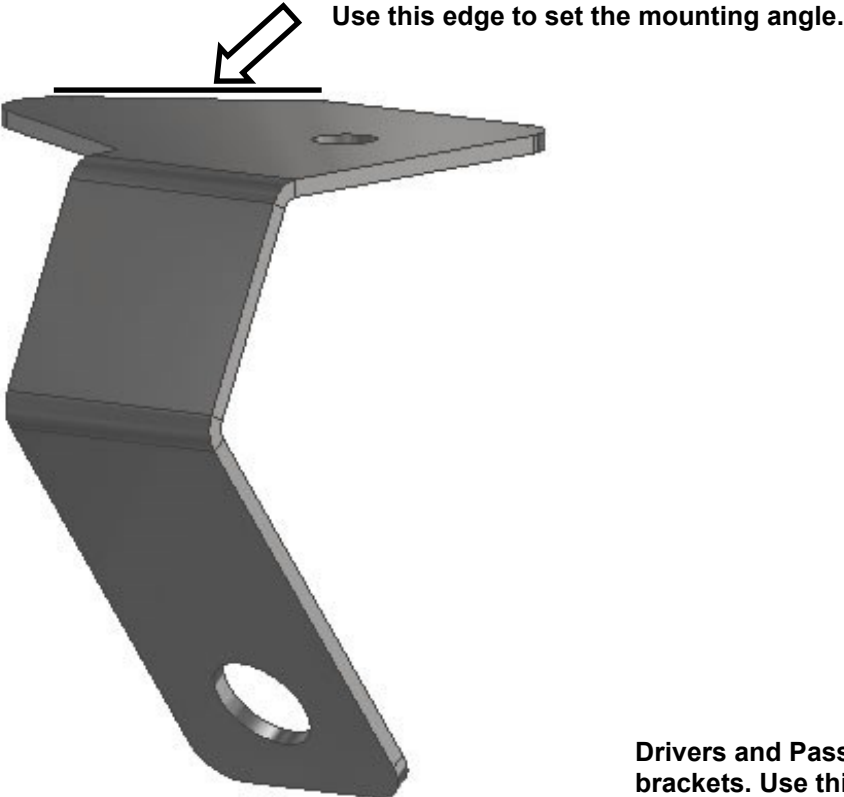

Drivers Side Front Mounting Bracket (x1)

Drivers and Passengers Front mounting brackets. Use this edge to set the mounting angle onto the body mount. See Step 32. and Photo 31.



Passengers Side Front Mounting Bracket (x1)

## INSTALLATION INSTRUCTIONS

1. Park the vehicle on a level surface and chock the rear wheels.
2. Jack up the front of the vehicle. Place jack stands under the frame rails and lower onto jack stands letting the front suspension hang.
3. Remove the tires and wheels using a 19mm socket.
4. Remove the 2 small screws from the front of the fender liner, using a 8mm socket. **See Photo 1.** Save for reuse.
5. Remove the 2 bolts from the top of the fender liner, using a 10mm socket. **See Photo 2.** Save for reuse.

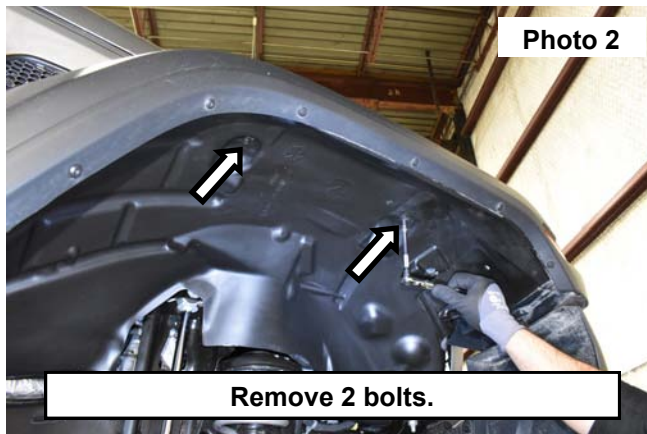

6. Using an auto trim puller, remove the 2 push pins in the front and the 3 in the top center of the fender liner. **See Photo 3 and 4.**

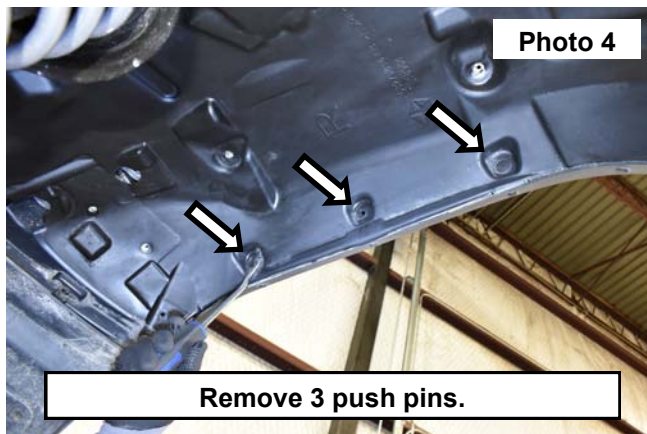
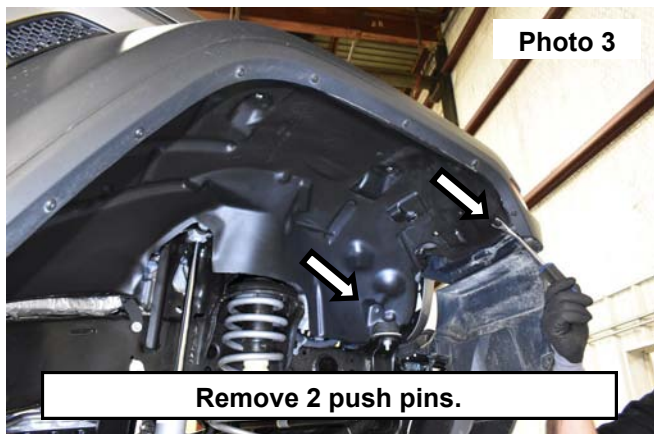

7. Using a auto trim puller, remove the rear 2 push pins in the rear lower fender liner. **See Photo 5.**
8. Release the fender liner from the 3 plastic rivets on the edge of the fender, use an auto trim puller to help release. **See Photo 6.** Leave the 3 rivets in the fender.

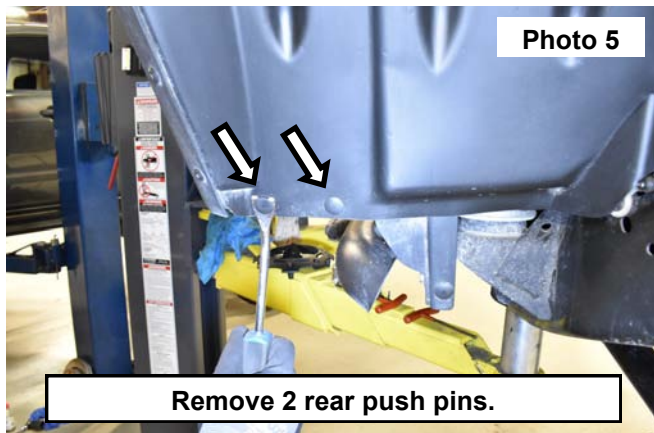

9. Remove the fender liner. Set aside this will not be reused. **See Photo 7.**
10. Located at the front of the fender remove the 2 bolts, using a 10mm socket. **See Photo 8.** Save for reuse.

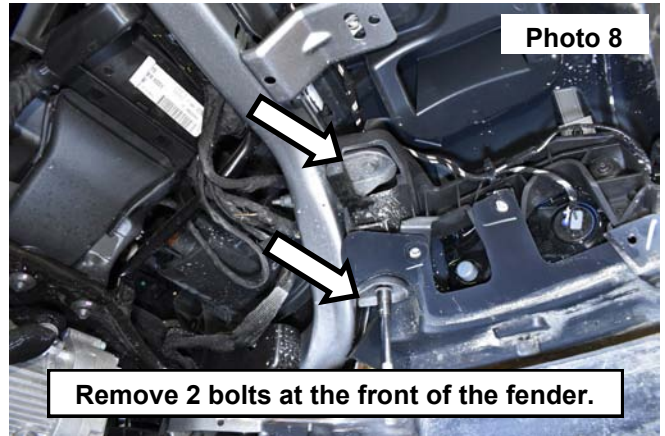
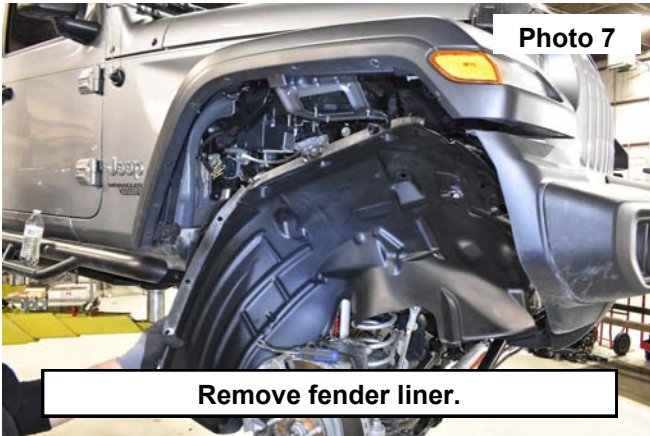

11. Pull the red locking tab back, push the clip and disconnect the light wiring harness from the jeep. **See Photo 9.**
12. Using care not to break any clips, these will be reused to install the fender back onto the vehicle, release the 11 clips from the back side of the fender, use long nose pliers. **See Photo 10.**



13. Once all of the clips are released from the back side, remove fender, set in a safe place for modification. **See Photo 11.**
14. Removing clips, please make note of the arrows in Photo 12, from the front of the fender back remove the 3rd and 4th clip, 7th and 11th clip, from the fender. **See Photo 12.**

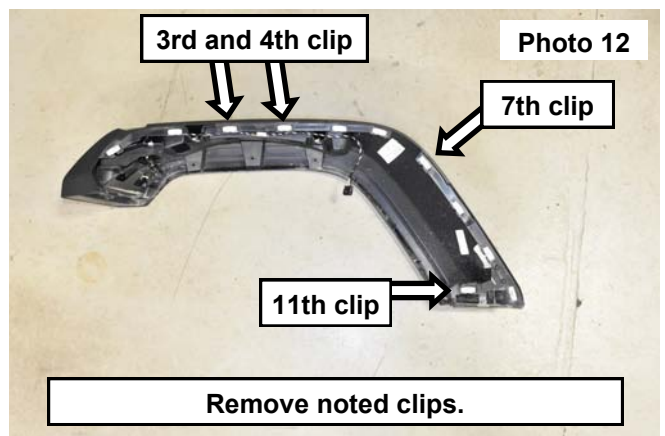
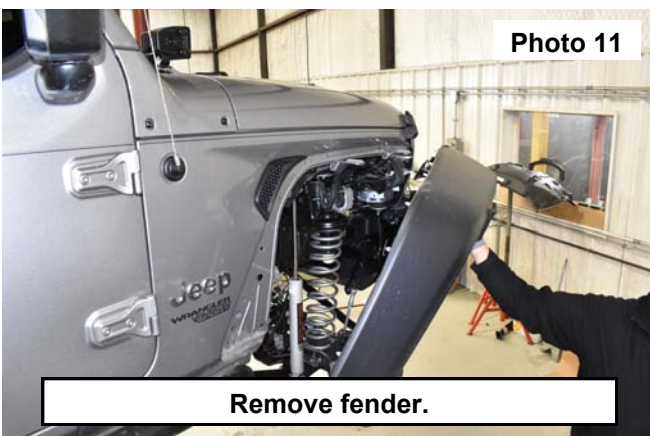

15. Release the tabs in between the fender and remove the 3rd and 4th clips. **See Photo 13.**

16. Remove the 7th and 11th clip on the rear and bottom of the fender. **See Photo 14.**

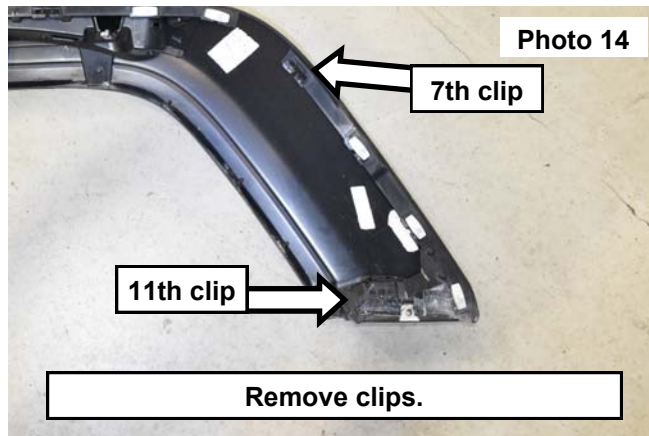
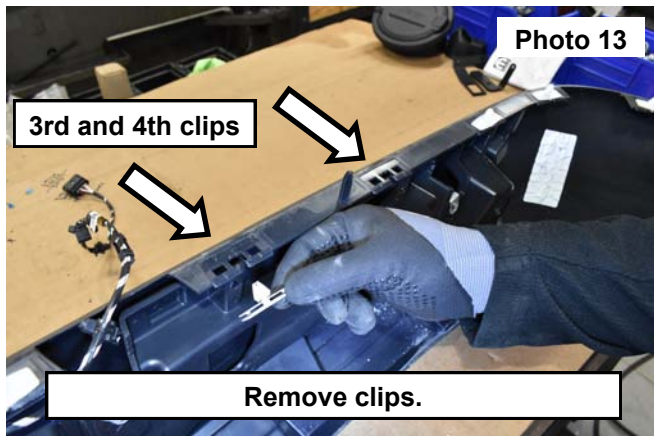

17. Using an auto trim puller remove the push pins attached to the wiring harness running through the top of the fender. **See Photo 15.**

18. Mark the area to be removed behind the 3rd and 4th clip openings in the top of the fender, mark just behind the raised area in the 3rd hole and mark a 1" wide area on the 4th hole to be trimmed out for bolt and tool access for installation of the inner fenders. **See Photo 16.**

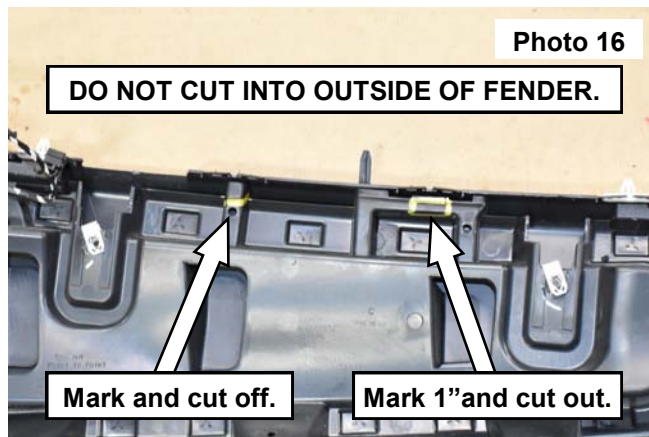
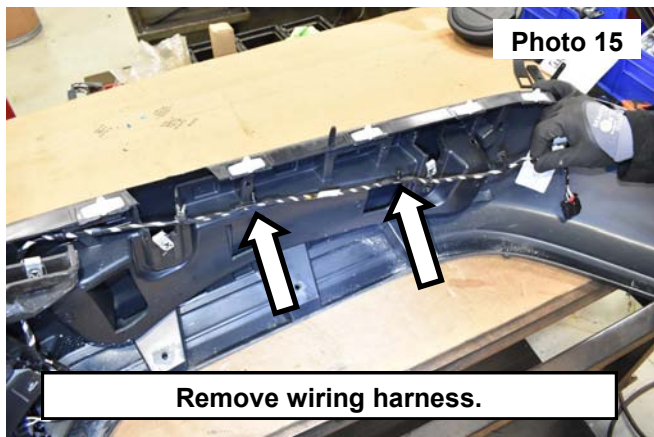

19. Trim marked area's using a body saw. **See Photo 17.**

20. After trimming the marked area's smooth any jagged parts using a file or sand paper. **See Photo 18.**

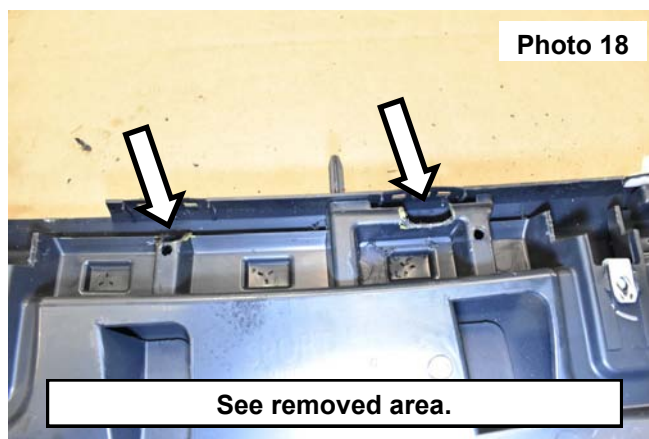
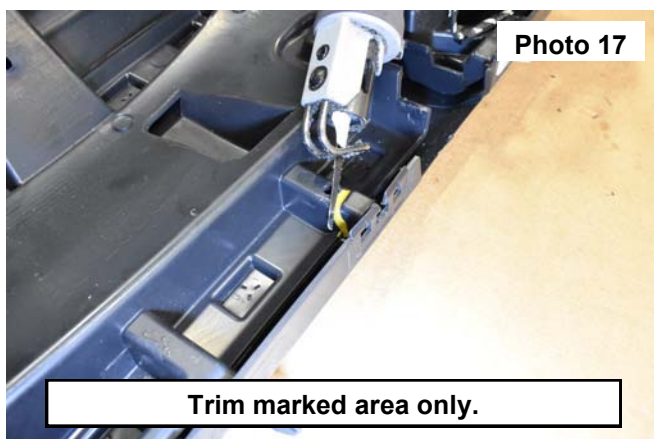

21. Mark the 3 highlighted lines on the inner structure to be trimmed for bolt and tool access. **See Photo 19.**  
 22. Using a body saw trim the 3 highlighted lines on the inner structure. **See Photo 20.**

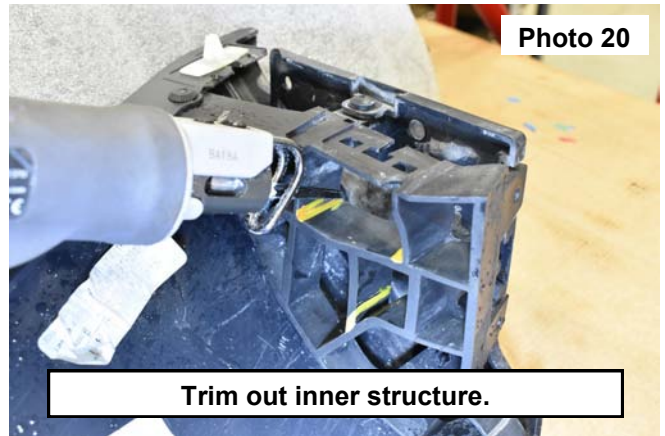
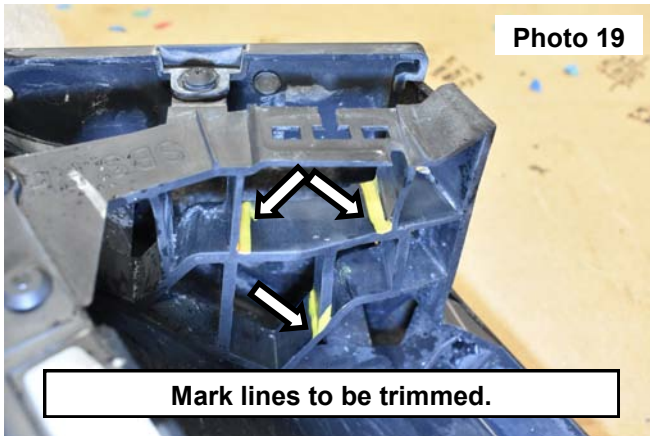

23. Remove trimmed part from fender and discard. **See Photo 21.** After trimming the marked area's smooth any jagged parts using a file or sand paper.  
 24. Reclip the wire back into the original location, install the fender back onto the vehicle, secure using the clips on the back of the fender into there original holes. **See Photo 22.**

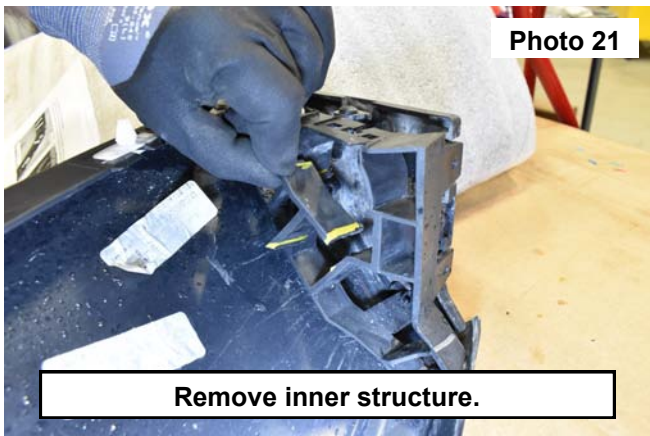

25. The kit picture below is to show were the 6mm body clips go and their appropriate hardware. **See Photo 23.**

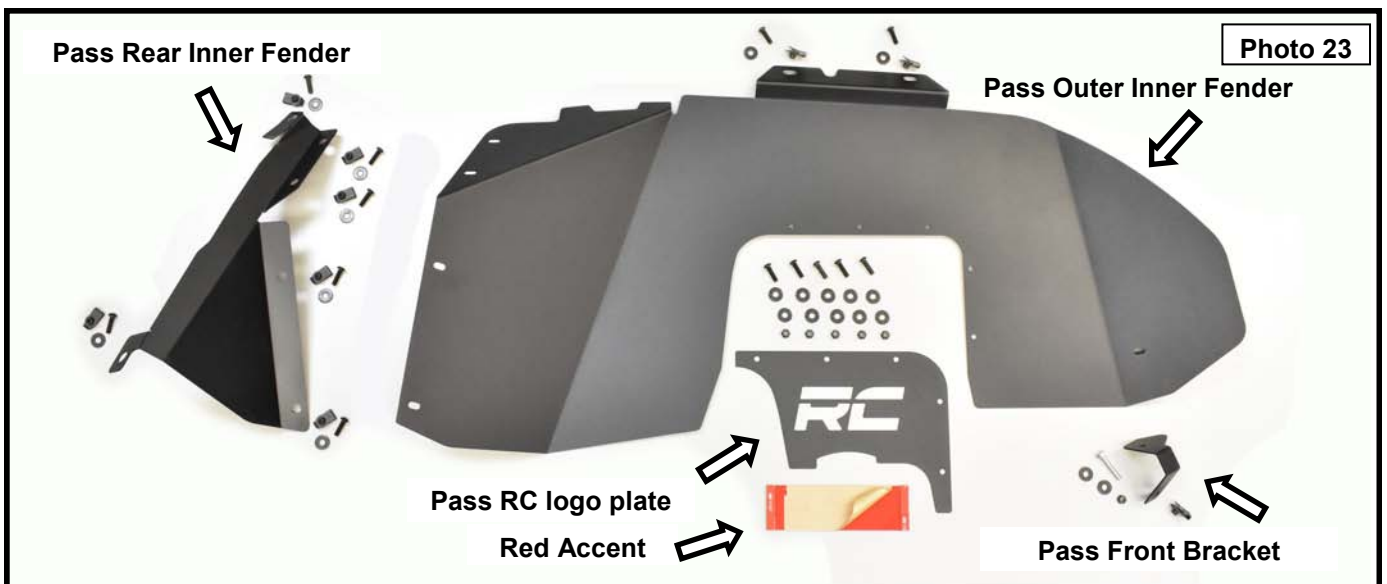

View placement of the 6mm body clips.



26. Install the (6) 6mm body clips onto the rear inner fender panel. **See Photo 24.**

27. Install the rear inner fender panel into the rear of the vehicle. **See Photo 25.**

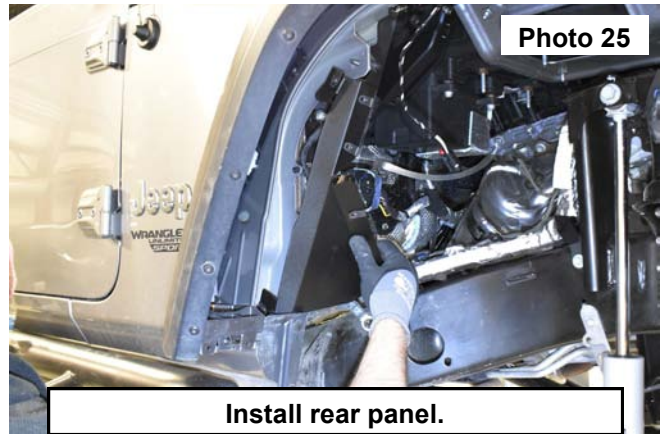

28. Secure the rear inner fender to the vehicle using the supplied 6mm-1.0x 20mm Hex head bolt and 6mm washer, use a 10mm wrench to tighten. **See Photo 26 and 27.**

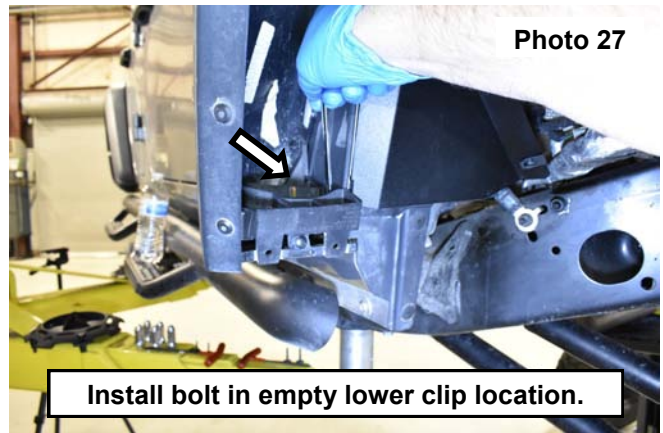
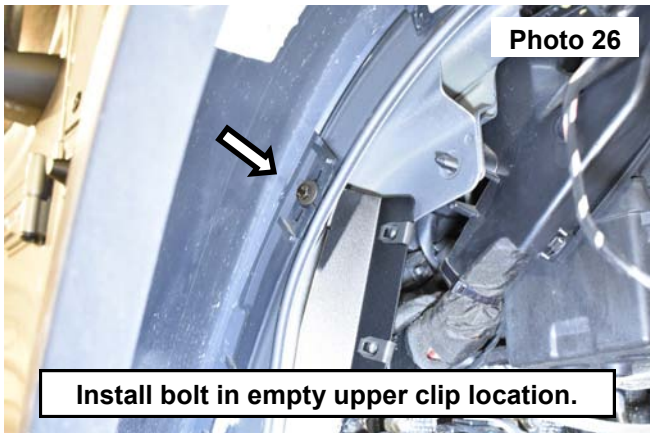

29. Locate the front inner fender bracket, 6mm body clip, 6mm-1.0x 35mm hex head bolt, (2) 6mm washers and 6mm nylock nut, install the 6mm clip onto bracket. **See Photo 28.**

30. Remove the bolt located on the front body mount. **See Photo 29.**

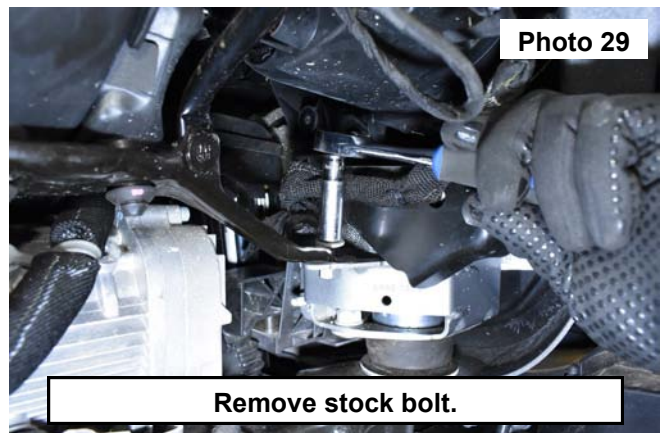
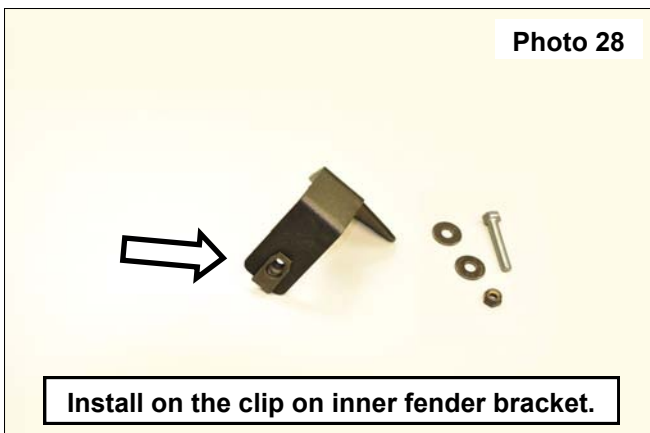

31. Install the 6mm-1.0x35mm bolt and washer into the location of the original bolt making a mounting point for the inner fender bracket, use a 10mm socket to tighten. **See Photo 30.**
32. Install the inner fender mounting bracket onto the installed 6mm-1.0x35mm bolt, seat the bracket onto the nut on the bottom of the body mount bracket, Described on the 2nd page of this instruction sheet. Use the edge to set the mounting angle onto the body mount. Tighten using a 10mm wrench. **See Photo 31.**

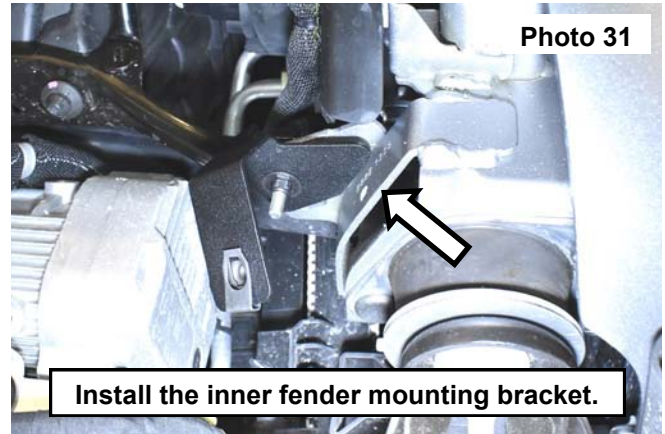

33. Install the (2) 6mm body clips onto the inner fender panel on the top of the mounting point. **See Photo 32.**
34. Only install the (5) 6mm-1.0 x20mm bolts, washers and nylock nuts. if your installing these inner fenders with the Rough Country Vertex shocks installed on the vehicle. If so tighten using a 4mm allen wrench and a 10mm socket on the nut, turn the nut only to prevent chipping the powder coat off of the outside. **See Photo 33.** Do not install logo panel at this time.



35. Install the outside panel onto the vehicle, using (2) Hex head 6mm-1.0 x20mm bolts and washers, Snug the 2 bolts using a 10mm wrench. **See Photos 34 and 35.**

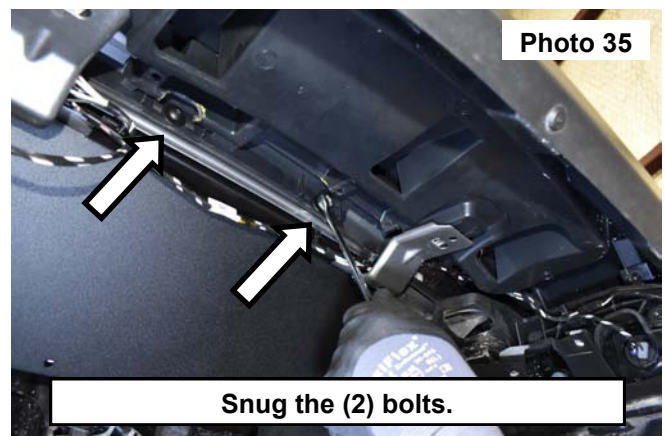
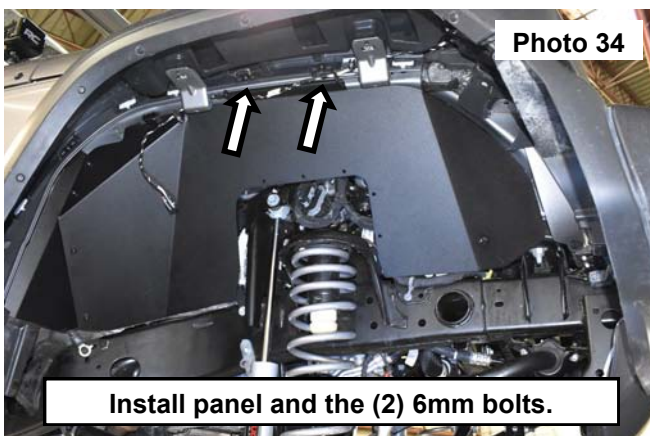



36. Install the (4) 6mm-1.0 x20mm button head bolts and washers in the rear of the panel. **See Photo 36.**  
37. Install the (1) 6mm-1.0 x20mm button head bolt and washers in the front of the panel. **See Photo 37.**  
38. Tighten the top center 2 bolts installed in photo 34 and 35. using a 10mm wrench.

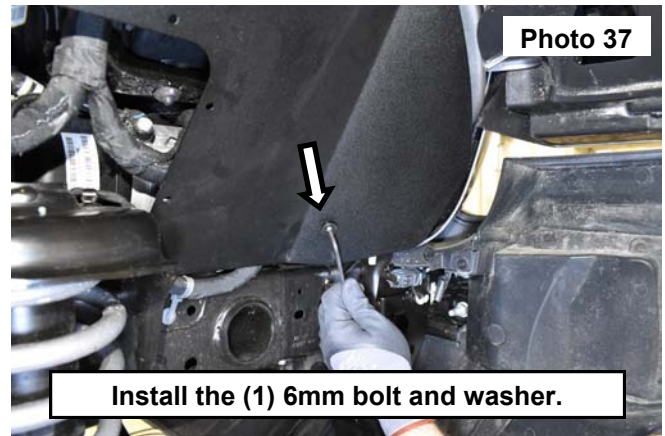

39. Install the 2 factory screws in the front of the fender, tighten using an 8mm socket. **See Photo 38.**  
40. Install the 4 factory bolts into the fender, tighten using a 10mm. **See Photo 39.**



41. Connect the wiring harness into the factory plug, push in the red locking tab. **See Photo 40.**  
42. Peel the protective cover off of the red accent. **See Photo 41.**



43. Locate the RC logo plate, peel the covering from the double sided tape on the front side of the red accent, align the red accent over the RC logo securing the accent to the RC logo plate with the double sided tape. **See Photo 42.**
44. Install the RC logo plate into the outside panel. **See Photo 43.**



45. Secure the RC logo plate to the outside panel, using the supplied 6mm-1.0 x20mm button head bolts, washers and nylock nuts. Turn the nut to tighten the bolts to prevent any powder coat damage. **See Photo 44.**
46. Repeat steps on opposite side. Check all hardware to be tight. **See Photo 45.**



47. Install the front wheels and tires, tighten using a 19mm socket.
48. Lift the vehicle up and remove the jack stands, then lower the vehicle back onto the ground.

By purchasing any item sold by Rough Country, LLC, the buyer expressly warrants that he/she is in compliance with all applicable , State, and Local laws and regulations regarding the purchase, ownership, and use of the item. It shall be the buyers responsibility to comply with all Federal, State and Local laws governing the sales of any items listed, illustrated or sold. The buyer expressly agrees to indemnify and hold harmless Rough Country, LLC for all claims resulting directly or indirectly from the purchase, ownership, or use of the items.

