



Installation Instructions

VI-COWL

Product Number: VC4500

2018 FORD F150

SAFETY

Your safety and the safety of others is very important.

- In order to help you make informed decisions about safety, we have provided installation instructions and other information.
- These instructions alert you to potential hazards that could hurt you or others.
- Please do a job safety analysis (JSA) before each task to identify potential hazards for your situation and remove/protect against them.
- You must use your own good judgment, and take your time.

Read and understand all safety precautions and instructions before installing this product.

THIS PRODUCT IS FOR OFFROAD USE ONLY. ALL LIABILITY FOR INSTALLATION AND USE RESTS WITH THE OWNER.

CARELESS INSTALLATION AND OPERATION CAN RESULT IN SERIOUS INJURY OR EQUIPMENT DAMAGE.

Injury hazard

Failure to observe these instructions could lead to severe injury or death.

- Always** remove jewelry and wear eye protection.
- Always** use appropriate and adequate care in lifting components into place.
- Always** insure components will remain secure during installation and operation.
- Always** wear safety glasses when installing this kit
- Always** use extreme caution when cutting and trimming during fitting.
- Always** tighten all nuts and bolts securely per installation instructions.
- Always** perform regular inspections and maintenance on mounts and related hardware.





Installation Instructions

VI-COWL

Product Number: VC4500

2018 FORD F150

Overview

Congratulations on your new purchase of the Fab Fours Vi-Cowl Accessory.

Your Vi-Cowl was designed in 3-D from digitized data, CNC laser cut, fabricated, and powder coated... all in the U.S.A. Enjoy the fit and finish of a Vi-Cowl from Fab Fours, Inc.

Contents

- SAFETY**..... 1
- Injury hazard** 1
- Overview..... 2
- I. Tools Required 3
- II. Factory Vehicle Prep..... 3
- III. Wiper cowl modification 6
- IV. Fab Fours hood hinge installation..... 6
- V. Hood Installment..... 8
- VI. ViCowl Pre-Assembly 9
- VII. ViCowl Installation..... 12
- VIII. Maintenance/Care..... 19
- IX. Contact Information..... 19
- More than expected... Better than expected.** 19





Installation Instructions

VI-COWL

Product Number: VC4500

2018 FORD F150

I. Tools Required

- 3/16" Allen Wrench
- Open End Wrench
- Socket Set and Ratchets
- Scissors
- Drill Bit – 1/4"
- Blue Painters Tape
- Knife
- Pick or Small Flat Head Screwdriver

II. Factory Vehicle Prep

- a. Apply Blue tape on each side of the hood and fender. Mark the tape with a straight-line perpendicular with the hood and fender body seam. Use a knife to cut the tape along the same seam.

Note: Step one is recommended to assist you in realignment of the hood during reassembly.



Fig 1





Installation Instructions

VI-COWL

Product Number: VC4500

2018 FORD F150

- b. Loosen the four nuts that secure the hood to the upper hood hinge bracket, so they can be removed by hand as shown in **Fig 1** indicated by the red arrows.
- c. Disconnect any electrical connections and washer fluid lines if your vehicle is equipped.
- d. With a friend on the other side, support the hood and fully remove the hood bolts and remove the hood.

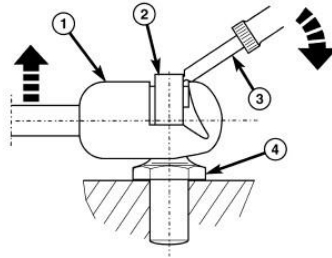

8070308

Fig 2

- e. Using a small pick or screwdriver, pry out on the metal spring clip shown in **Fig 2** Labeled (2). Pull the air spring head (1) away from the ball stud (4) while the spring clip is pulled away. Disconnect the air spring from the bracket only, leave attached to frame rail. Rotate forward out of the way.

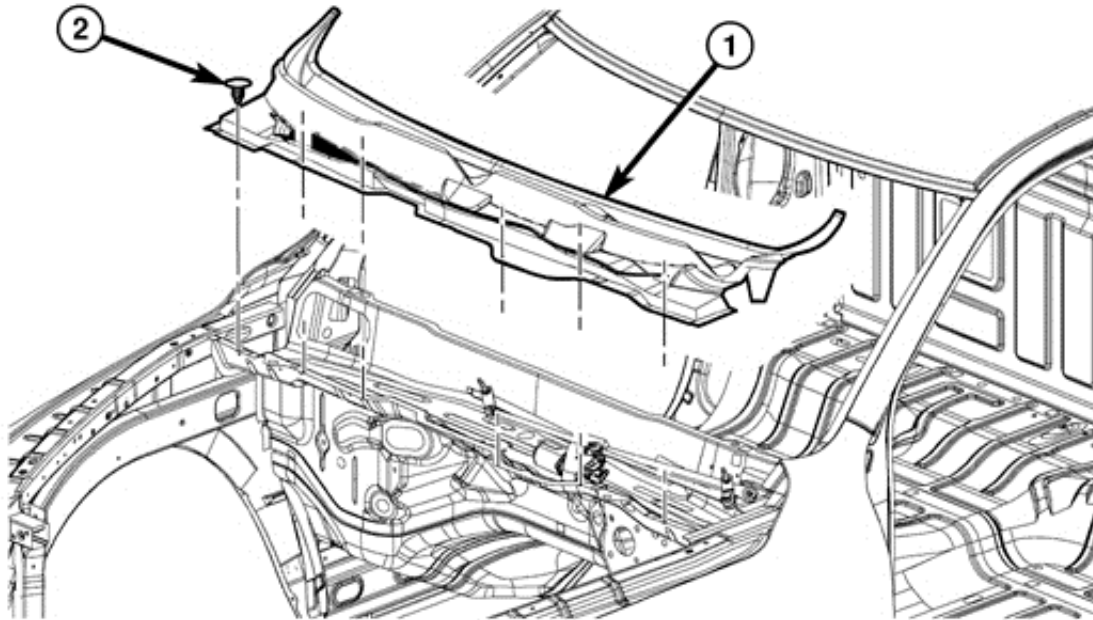

Fig 3.





Installation Instructions

VI-COWL

Product Number: VC4500

2018 FORD F150

- f. Remove the 6 plastic retainers as shown in **Fig 3** labeled (2).
- g. Remove the wiper arms.
- h. Unclip the wiper cowl from the windshield by pulling up and unclipping the plastic clips.



Fig 4.



Fig 5.

- i. After removing the cowl, you may need to remove some stubborn clips from the sheet metal by turning them 90° and releasing them. Reattach the plastics clips to the underside of the cowl for future reinstallation as shown in **Fig 4&5**.
- j. Remove the cowl and set aside for trimming.

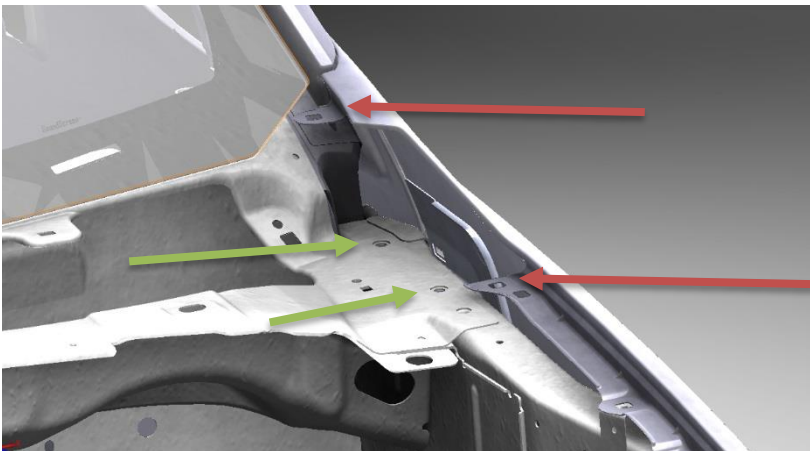

Fig 6.

- k. Remove the two bolts that secures the fender to the hood hinge bracket near the windshield indicated in **Fig 6** by the red arrows on the right.
- l. Remove and save the two bolts from **Fig 6** indicated by the green arrows on the left.
- m. Set the OEM hood hinge bracket aside, it won't be used again.





Installation Instructions

VI-COWL

Product Number: VC4500

2018 FORD F150

III. Wiper cowl modification

- a. Both ends of the cowl need to be trimmed so that the ViCowl brackets clear the cowl in the down position.



Fig 7

- b. Trim off the areas as shown in Fig 6 & 7 on both sides of the cowl.

Note: some minor additional trimming may be needed in areas marked to cut.

IV. Fab Fours hood hinge installation

Note: Both driver side and passenger side brackets install the same way.





Installation Instructions

VI-COWL

Product Number: VC4500

2018 FORD F150

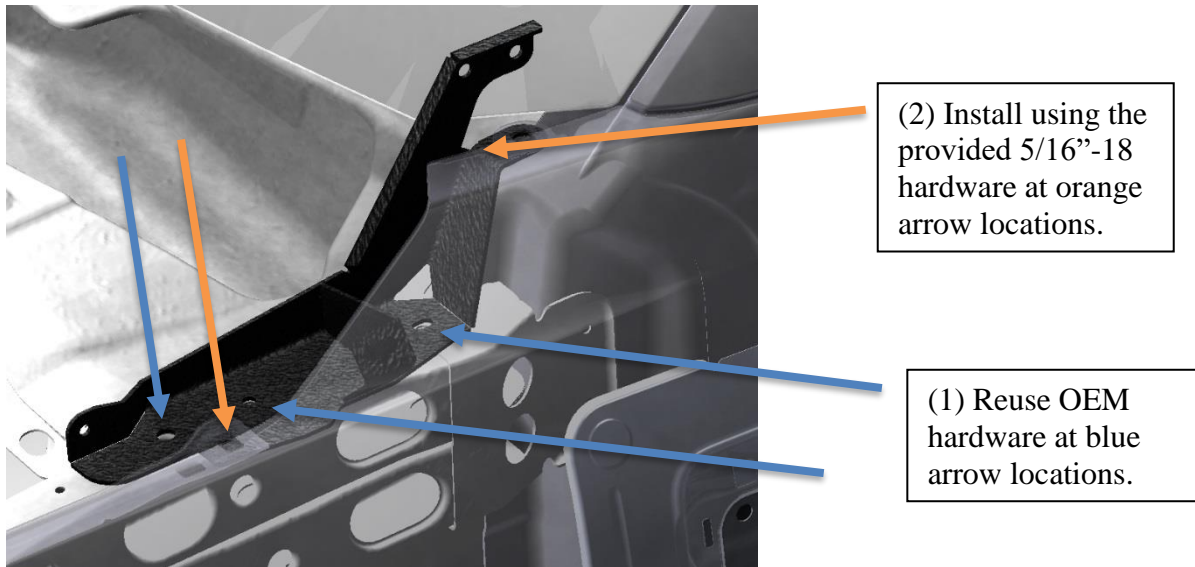

Fig 8

- Position the driver side bracket as pictured in **Fig 8**.
- Loosely install the three factory bolts as shown in **Fig 8** item (1).
- Install the outer two 5/16"-18 zinc bolt, zinc lock washer and zinc flat washer as shown in **Fig 8** item (2).
- Fully tighten down all bolts.
- Repeat the same procedure for the passenger side bracket.

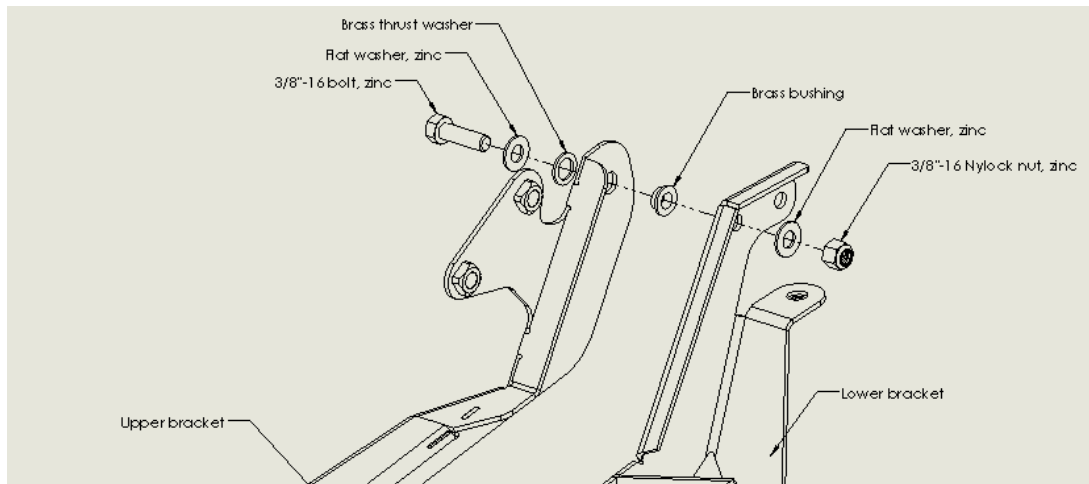

Fig 9

- Press install the brass bushing into the upper hole in the Upper arm as shown in **Fig 9**.





Installation Instructions

VI-COWL

Product Number: VC4500

2018 FORD F150

- g. Insert the 3/8"-16 bolt with washer and thrust washer into the brass bushing as shown in **Fig 9** forming the upper arm sub assembly.
- h. Insert the upper arm sub assembly into the front bracket hole with washer and 3/8"-16 Nylock nut.
- i. Holding the upper arm and bolt stack tight to the lower bracket, tighten the Nylock nut being careful that the trust washer doesn't pop out from the brass bushing.



- j. Take the ball point bolt along with the nylock nut and attach it to the upper hood hinge as shown above.



- k. Take the air shocks and reattach them to the new hinges as shown above.

V.Hood Installment

- a. With a friend, lift the hood onto the upper arm of the hood bracket and install the four factory nuts hand tight.





Installation Instructions

VI-COWL

Product Number: VC4500

2018 FORD F150

- b. Align the upper arm with the missing paint marks made under the hood from the factory brackets. This will get you close as the Fab Four brackets have identical profile.
- c. Lower the hood slowly and check for uniform hood gap.
- d. Adjust as needed.
- e. Slowly raise the hood just enough to reach in with a ratchet and fully tighten down the four factory bolts securing the hood.
- f. Raise the hood fully and reconnect the gas assist springs on the ball joint on the hinge upper arm.

Note: be mindful of how high you raise the hood while making adjustments to alignment. It is possible that the hood will shift without your knowledge if hood is raised too high.

VI.ViCowl Pre-Assembly

Note: It's highly recommended that all projection weld nuts are chased with the appropriate taps to clean out any powder coat or foreign debris prior to assembly. Tap sizes needed to do this are 1/2"-13, and 3/8"-16





Installation Instructions

VI-COWL

Product Number: VC4500

2018 FORD F150

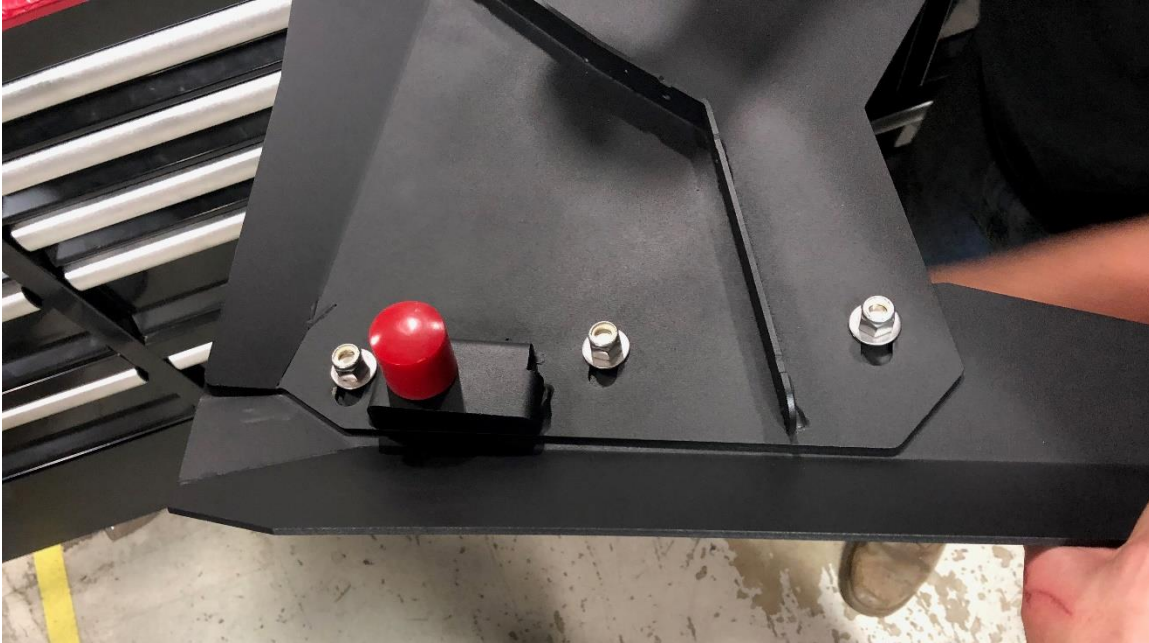

Fig 11

- a. Install and hand tighten the rubber bumpers and 1/2" flat washers to the visor as shown in **Fig 11**.
- b. Install loosely the Visor trim (or light insert if purchased) into the back of the visor using the provided 5/16"-18 stainless steel bolts, rubber bonded washer, flat washer, and 5/16"-18 Nylock nut.

Note: The rubber bonded washer is used on the outside surface of the visor to reduce any powder coat wear marks what would otherwise be created using regular flat washers and visible if bolts are moved due to reassembly of visor with light insert.

- c. Fully tighten all visor trim hardware

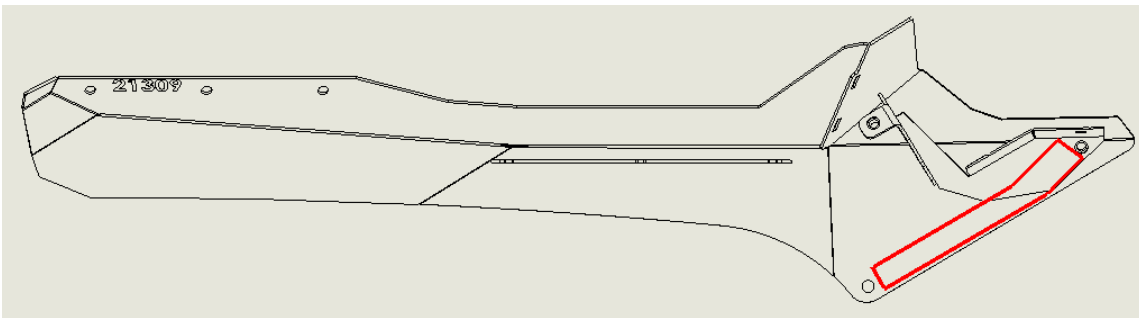

Fig 12





Installation Instructions

VI-COWL

Product Number: VC4500

2018 FORD F150

- d. Install the 1" neoprene rubber strip to the inside of both arms as shown in **Fig 12** highlighted in red.

Note: leave about a 1/8" reveal on the edge of the arms. This will ensure the rubber strip doesn't shift or show after installation.

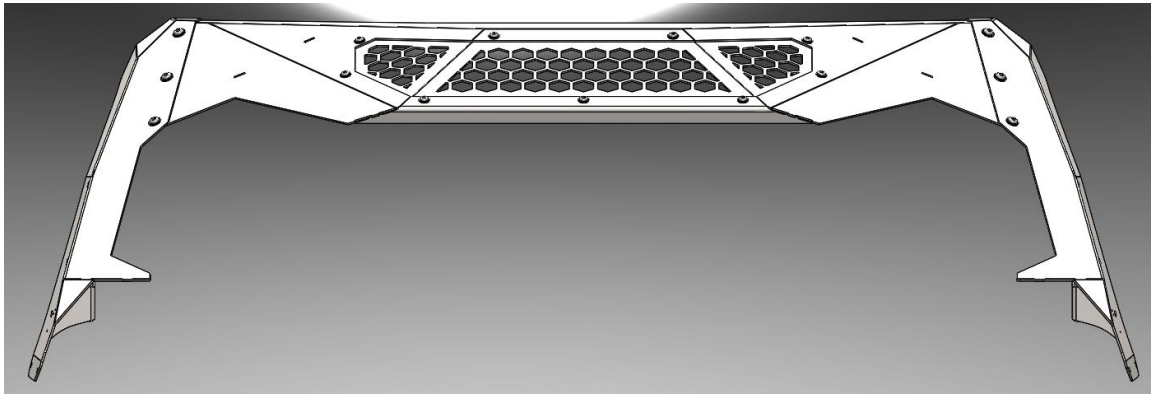

Fig 13

- e. Loosely install both ViCowl arms to the visor using the provided 3/8"-16 stainless steel bolts and rubber bonded washers as shown in **Fig 13**.



Fig 14

- f. Install the edge seal with adhesive onto the leading edge of the cowl as shown in **Fig 14** by the highlighted red line.

Note: don't stretch the seal as you apply it to the Cowl. This will ensure it doesn't pull away from the sheet metal later.

- g. Trim the edge seal for fit and finish
- h. The ViCowl is now prepped for install.





Installation Instructions

VI-COWL

Product Number: VC4500

2018 FORD F150

VII.ViCowl Installation

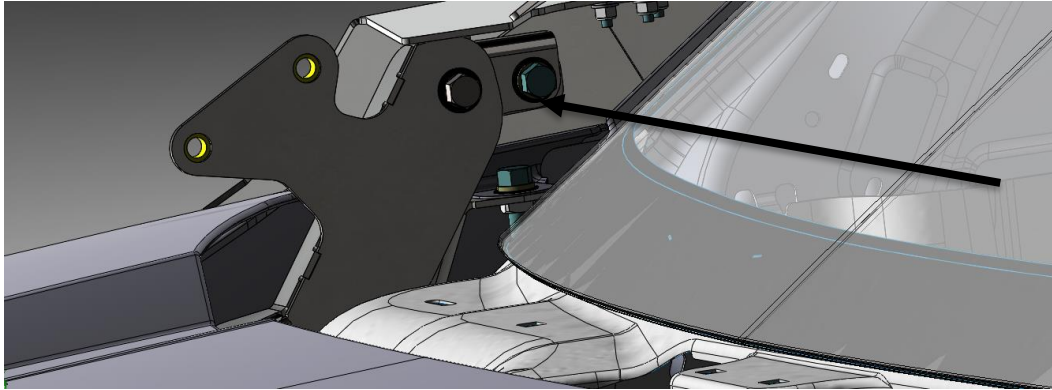

Fig 16

- a. With a friend on the other arm, lift the upper ViCowl assembly up over the hood and slowly lower the arms into position. The arm mounting bracket rest to the outside of the lower hinge and lined up with the rear bolt hole as shown in **Fig 16**.
- b. Loosely install the $\frac{3}{8}$ "-16 hex bolt, zinc lock washer, and zinc flat washer through the lower hinge bracket and into the arm securing the ViCowl from falling lower on the vehicle as indicated in Fig 12 with the black arrow.
- c. Check for fit and fully tighten down both arms to the hinge brackets.





Installation Instructions

VI-COWL

Product Number: VC4500

2018 FORD F150

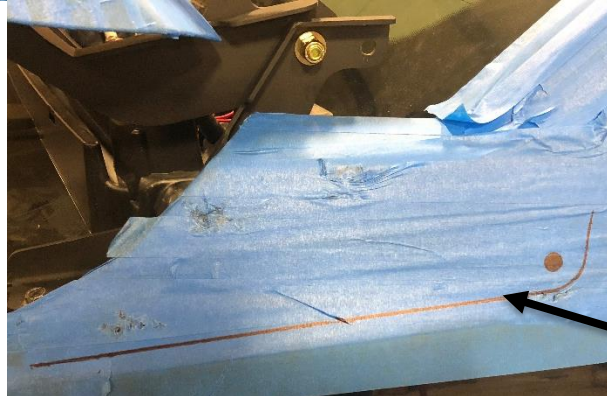
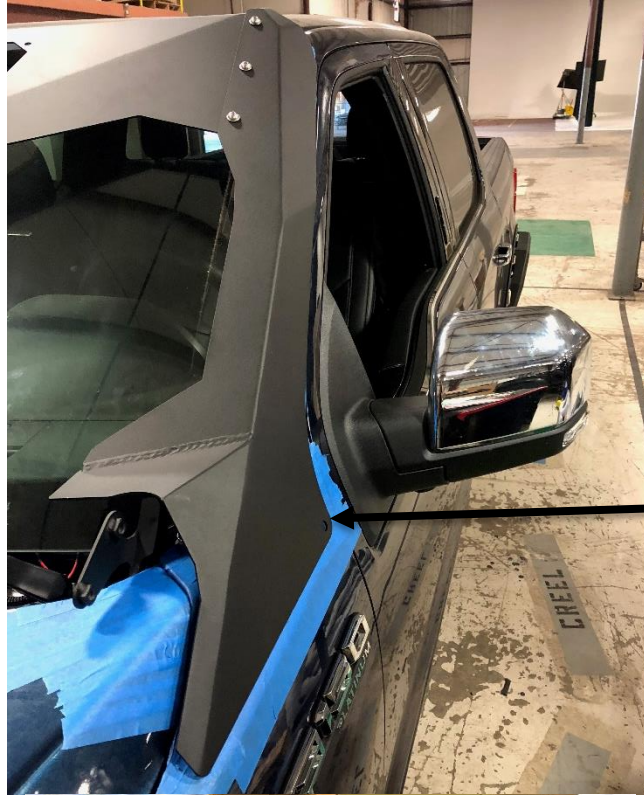

Fig 17

- d. Mark the Rivnut hole location as indicated in **Fig 17** by the black arrow and on both driver and passenger arms. Before removing the ViCowl for drilling, mark the lower profile of the arm with a Sharpie as shown for the template reference.

Note: A high degree of accuracy is needed when marking the Rivnut locations. The four Rivnuts constitute a majority percentage of the mounting strength of the upper ViCowl to the vehicle. A hole center punch is recommended followed by incremental pilot holes to the finish hole size of the included 17/32" drill bit. You will have trouble lining up all three bolt holes per side if Rivnuts are misplaced.





Installation Instructions

VI-COWL

Product Number: VC4500

2018 FORD F150

- e. Remove the upper ViCowl assembly in preparation to drill and install four Rivnuts in the fenders.
- f. Use the 1/8" Drill bit to drill pilot holes in all of the marked locations. Be careful to drill directly perpendicular to the side of the fender. Be sure to drill the holes to a depth of 7/8".
- g. Step up to the 1/4" Drill
- h. Final drill out the holes with the 17/32". If available, a sheet metal Uni-Bit or step drill bit can be used after the 1/4" Bit.
- i. With the expendable tool threaded into the nutsert, insert it into one of the holes making sure that it fits in far enough to flush the collar of the nutsert to fender panel. (For an exceptional installation coat the knurls of the Nutsert with Loc-tite.)
- j. Place the 9/16" Box end wrench on the body of the expendable tool and the 9/16" socket and ratchet on the bolt head on the back side of the tool. See image below.



Fig 18

- k. Tighten the bolt into the nutsert until it becomes snug in the fender panel. **DO NOT OVERTIGHTEN CAUSING THE INSERT TO SPIN!**
- l. Repeat steps "f-k" on the remaining holes.





Fig 19.

- m. Align the drill template for the front stud hole on the fender using the rear nutsert as a locating feature as shown in **Fig 19** and indicated by the red arrow. The front hole to be drilled should be directly over top of the slot in the lower hood hinge bracket. Precision for the future hole size and shape isn't required as the hole in the fender will merely be a pass through hole. Aline the template with the sharpie outline you created earlier and mark your second hole for drilling.

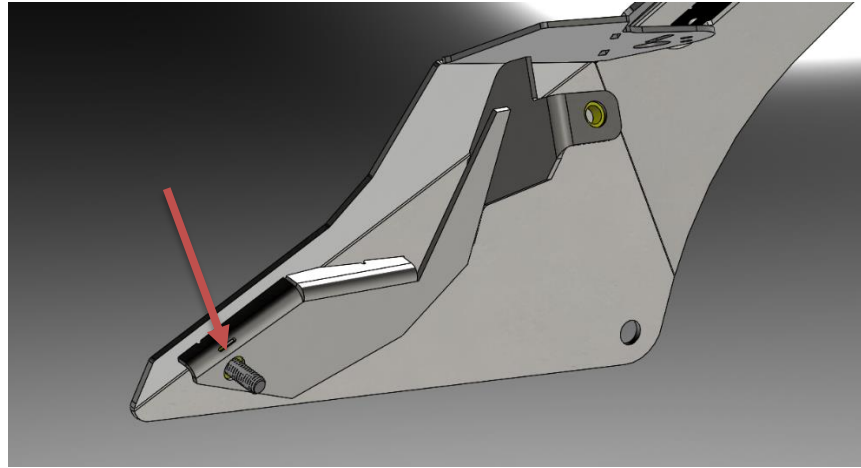

Fig 20.

- n. Using blue Lock tight, install the included stud into both arms of the Vicowl as shown in **Fig 20** and indicated by the red arrow.
- o. Reinstall the upper ViCowl using steps “a-b”. stretch the arms a bit to insert the arm studs into the front fender hole made earlier. The stud should pass through both the fender and the slot in the lower hood hinge bracket. Prior to lowering the arms down, reconnect the factory antenna lead at this time.
- p. Install the $\frac{3}{8}$ "-16 stainless steel button head bolts, rubber bonded washers, and blue Locktight.
- q. Install the $\frac{3}{8}$ "-16" flat washer, lock washer, and nut on the arm stud from inside the engine bay.
- r. Fully tighten down all hardware securing the upper ViCowl arms to the hood hinge brackets.



Fig 21

- s. With the help of a friend, lift the ViCowl cowl up over the hood and slowly lower it down on the mounting surface as shown in **Fig 21** indicated by the red arrows.

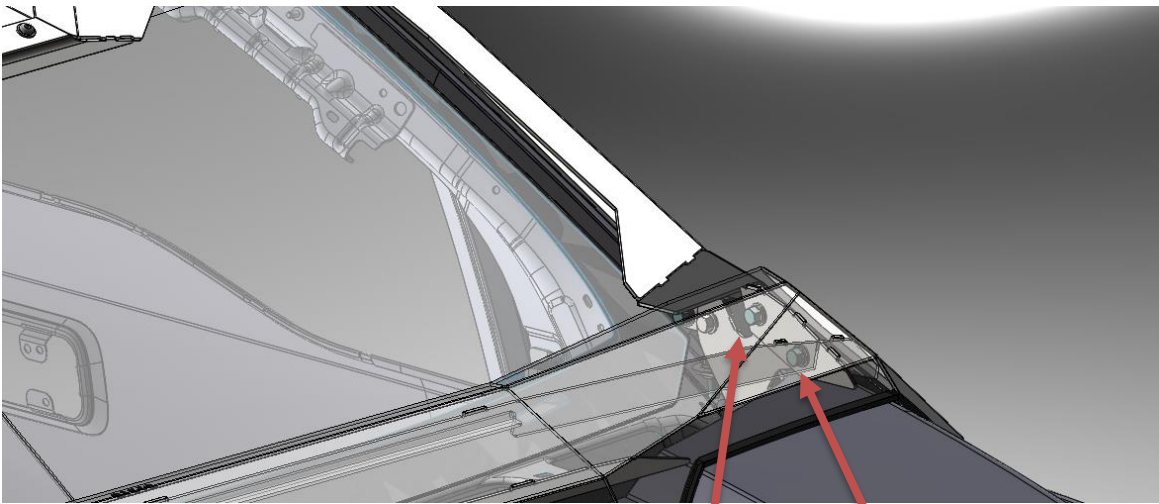

Fig 22

- t. Loosely install the four $\frac{3}{8}$ "-16 bolts, flat washers and lock washers into the cowl as shown in **Fig 22** and indicated by the red arrows.



Installation Instructions

VI-COWL

Product Number: VC4500

2018 FORD F150



Fig 23.

- u. Using a plastic panel pry bar, insert the prybar under the cowl and on top of the arm to maintain a symmetrical gap on each arm as shown in **Fig 23**.
- v. Push down the front of the Vicowl closing any gap that may be between the hood and the rubber seal of the cowl and fully tighten down the two bolts on that side.

Note: the use of an impact driver, long extension, and swivel will make tightening down of the cowl hardware much easier than a ratchet or wrench.

- w. Repeat steps u-v for the other side.
- x. Install your factory antenna to the antenna mount on the passenger arm.
- y. Congratulations, the installation is complete.





Installation Instructions

VI-COWL

Product Number: VC4500
2018 FORD F150

VIII.Maintenance/Care

- Periodically check and tighten all nuts.
- Stripped, fractured, or bent bolts or nuts need to be replaced.

IX.Contact Information

Fab Fours Inc.
Industrial Park Drive
Lancaster, SC 29720

Phone (803) 416-1100
Fax (970)-385-1914
Email Support@fabfours.com



More than expected... Better than expected.

