



INSTALLATION MANUAL
MATRIX FRONT BUMPER
PRODUCT NUMBER: X465X
APPLICATION: 2018 JEEP JL
2020 JEEP GLADIATOR



IMPORTANT SAFETY GUIDE | Your safety and the safety of others is very important.

In order to help you make informed decisions about safety, we have provided the following warnings, safety precautions, installation instructions, and other important information to alert you to potential hazards that could hurt you or others.

Please do a job safety analysis before each task to identify potential hazards for your situation and remove/protect against them. Use own good judgment and take your time.

Check packaged materials immediately upon arrival to ensure that all listed parts are included and undamaged.

Read and understand all warnings, safety precautions, and instructions before installing this product.

SENSORS FIELD OF VIEW MAY BE ALTERED WITH USE OF THE REPLACEMENT BUMPER.

WARNINGS

- Failure to observe the following warnings and instructions provided in this manual could lead to severe injury and/or death.
- For professional installation only. Careless installation and/or operation can result in serious injury, death, and/or equipment damage. All liability for installation and use rests with the user or consumer.
- Fab Fours, Inc. only approves installing this product according to these written instructions with the hardware provided. Failure to install according to these instructions will invalidate the warranty. This includes, but is not limited to, using alternative installation methods, hardware, or materials.
- This product is for off road use only.

SAFETY PRECAUTIONS

- Always remove jewelry and wear eye protection.
- Always use extreme caution when jacking up a vehicle for work. Set emergency brake and use tire blocks. Locate and use the vehicle manufacturers designated lifting points. Use jack stands.
- Always use appropriate and adequate care in lifting components into place.
- Always ensure components will remain secure during installation and operation.
- Always wear safety glasses when installing this kit. A drilling operation will cause flying metal chips. Flying chips can cause serious eye injury.
- Always use extreme caution when drilling a vehicle. Always disconnect power before welding. Thoroughly inspect the area to be drilled (on both sides of material when possible) prior to drilling, and relocate any objects that may be damaged.
- Always use extreme caution when welding a vehicle. Thoroughly inspect the area to be welded (on both sides of material when possible) prior to welding, and relocate any objects that may be a fire hazard. When welding in a cab, make sure the interior surfaces are covered (e.g., welding blanket) and a fire extinguisher is at hand.
- Always use extreme caution when cutting and trimming during fitting.
- Always tighten all nuts and bolts securely per installation instructions.
- Always route electrical cables carefully. Avoid moving parts, components that become hot, and rough or sharp edges.
- Always insulate and protect all exposed wiring and electrical terminals.
- Perform regular inspections and maintenance on mounts and hardware.

TABLE OF CONTENTS

- 2 SAFETY / DISCLAIMER
- 3 TABLE OF CONTENTS
- 4 A MESSAGE FROM THE OWNER
- 5 GETTING STARTED
- 6 PROVIDED MATERIAL
- 7 DISASSEMBLY
- 9 INSTALLATION
- 11 CONTACT

A MESSAGE FROM THE OWNER



Fab Fours' was born out of a passion for customizing vehicles and a love of the outdoors. Our engineering team uses the latest 3D design software to turn new product ideas into reality. In our factory, designs come to life with the combination of cutting edge technology for metal cutting and forming and an American workforce that puts its' heart and pride into every product.

From design and manufacturing, to quality and delivery, Fab Fours' mission is to be the market leader for steel truck and jeep accessories. We make sure a quality product is delivered on time, more than expected, better than expected to our customers.

Enjoy your new Fab Fours product. Welcome to the family!

Ereg Higgs

FOUNDER, FAB FOURS

GETTING STARTED

Before you begin the installation process of your new Fab Fours product, we suggest laying out all materials and parts on a pad or protective surface.

Failure to fully account for all components before beginning installation may leave vehicle immobile until part is acquired. Refer to the next pages as an inventory check.

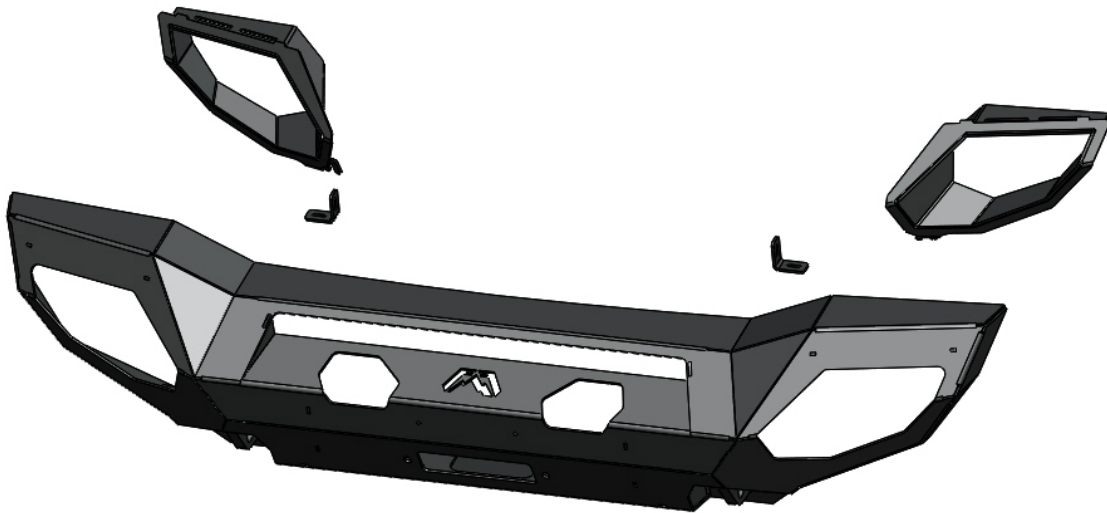

PROVIDED MATERIALS

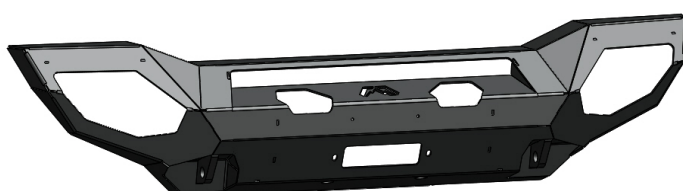

21935



21936



21937



21941
QTY: 2

HARDWARE KIT | 50188

FAB FOURS IDENTIFICATION	COMPONENT DESCRIPTION	QTY
50188-HW	7/16"-14, Yellow-zinc, Grade 8, Hex Nut	8
50188-HW	7/16", Yellow-zinc, Grade 8, Lock Washer	8
50188-HW	7/16", Yellow-zinc, Grade 8, Flat Washer	8
50188-HW	1/4"-20 x 1", Yellow-zinc, Grade 8, Hex head cap screw	2
50188-HW	1/4"-20, Yellow-zinc, Grade 8, Hex nut	2
50188-HW	1/4", Yellow-zinc, Grade 8, Flat washer	4
50188-HW	1/4", Yellow-zinc, Grade 8, Lock washer	2
50188-HW	5/16"-18 X 1.0", Yellow-zinc, Grade 8, Hex head cap screw	2
50188-HW	5/16", Stainless steel, Flat fender washer	2
50188-HW	5/16", Yellow-zinc, Grade 8, Lock washer	2

TOOLS REQUIRED

- 11/16" deep socket wrench
- 1/2" socket wrench
- 7/16" socket wrench
- 7/16" open end wrench
- 18mm deep socket wrench
- 16mm socket wrench
- Plastic panel pry tool
- Angle grinder
- Tape measure
- Painters' tape

ASSISTANCE

We recommend two people perform the installation as items are heavy and may need to be held in place while installing.

ORGANIZATION

Disassemble the vehicle where you can catalog and store everything. We suggest labeling and bagging all the OEM bolts when removing from the vehicle. Failure to keep track of parts could lead to an inability to properly reinstall components.

DISASSEMBLY

NOTE: Save all OEM parts until installation is complete!

1. Using painters' tape, cover the bottom 6" of the grille to prevent damaging the painted surface.

2. Using a plastic panel pry tool, remove the two (2) push pins from the valance piece of trim behind the bumper. (Figure 1)



Figure 1

3. Using an 18mm deep socket, remove the eight (8) nuts that hold the bumper to the frame horns. (Figure 2)



Figure 2

4. Disconnect the factory fog light wiring harness at the connector located on the passenger side frame rail. (Figure 3)



Figure 3

5. If equipped, use a 1/2" socket wrench to remove the six (6) bolts attaching the factory skid plate to the frame. (Figure 4)



Figure 4

6. If equipped, use a 16mm socket wrench to remove the two (2) bolts per side attaching the skid plate mounting brackets to the frame rails. (Figure 5)



Figure 5

INSTALLATION

NOTE: If installing a 30" light bar, do so now.

7. If installing a 30" light bar, use a 7/16" socket and open-end wrench to install the two (2) provided "L" shaped brackets (21941) to the mounting flanges in the bumper with the provided 1/4" Grade 8 screws, flat washers, lock washers, and nuts (50188-HW). (Figure 6)

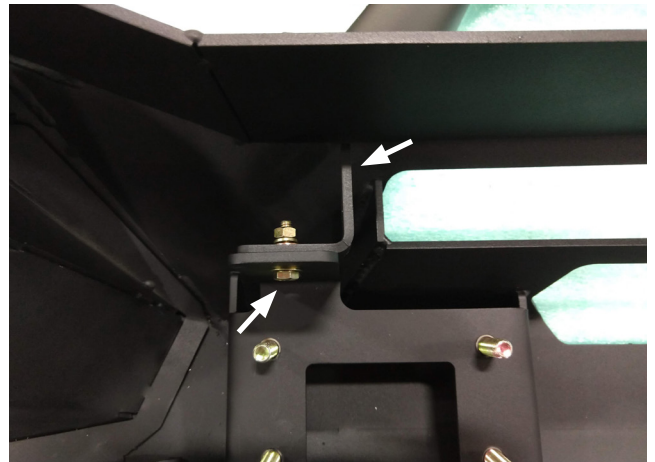

Figure 6

8. Using a 1/2" socket wrench, install the provided light box (21936) into the driver side of the bumper by sliding the tabs into the slotted bracket and threading the provided 5/16" Grade 8 screws, lock washer, and stainless steel fender washer (50188-HW) into the welded in nut in the bumper. (Figure 7-8)

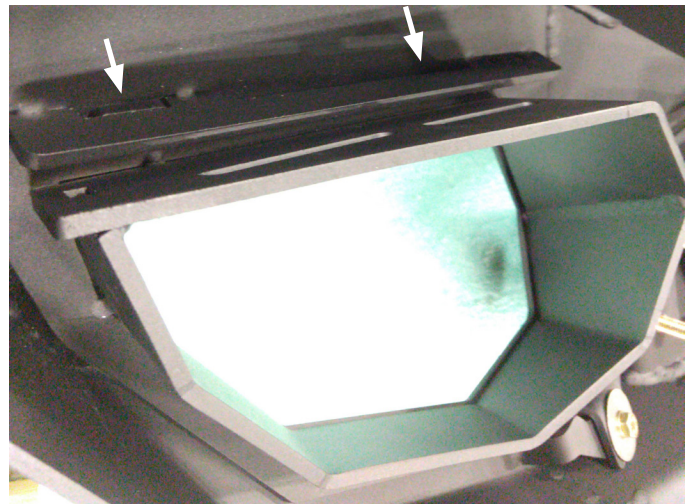

Figure 7



Figure 8

9. Repeat step 8 on the passenger side of the bumper with the remaining light box (21937).

10. If installing a winch, do a test fit with the winch sitting unbolted in the bumper. Place the bumper onto the frame horns and align the winch mounting holes with the mounting holes in the winch tray. The frame horns may need to be trimmed slightly to fit the winch. If trimming is necessary, use the angle grinder to remove NO MORE than 3/16" from the inside of each frame horn. (Figure 9)



Figure 9

11. Using an 11/16" deep socket wrench, install the bumper onto the vehicle using the provided eight (8) 7/16" Grade 8 flat washers, lock washers, and nuts. (50188-HW) (Figure 10)



Figure 10

CONTACT INFORMATION

**FAB FOURS INC.
2213 INDUSTRIAL PARK ROAD
LANCASTER, SC 29720**

PHONE: (866) 385-1905

FAX: 866-574-1423

EMAIL: SUPPORT@FABFOURS.COM

WWW.FABFOURS.COM



**“IF YOU’RE LOOKING FOR MORE OF THE SAME,
THEN YOU’VE COME TO THE WRONG PLACE.”**

- GREG HIGGS

